

Home Owner's

# THRIFT GUIDE

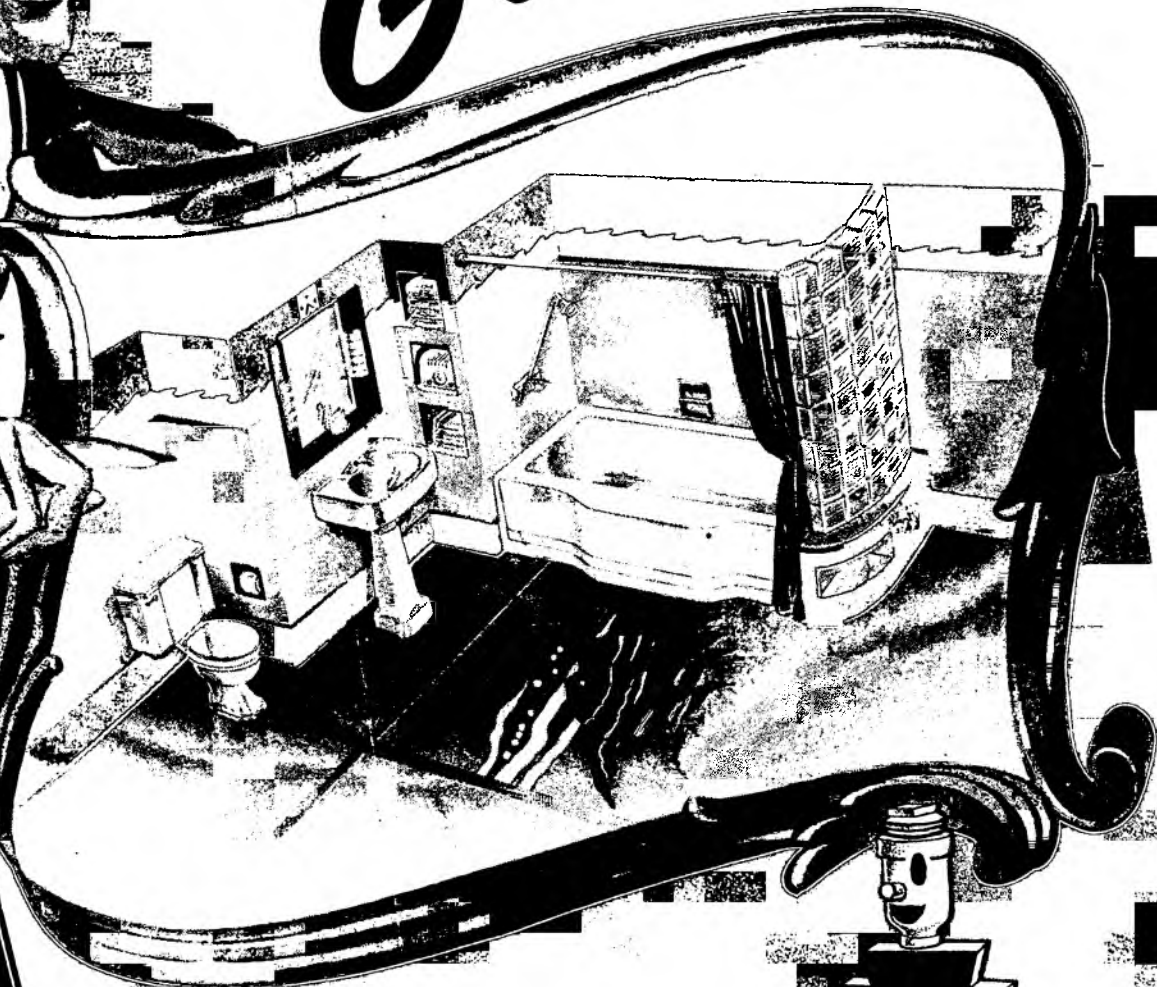

**THRIFT**  
HARDWARE & SUPPLY CO.

THIS BATH ROOM COMPLETE. . . . . **\$189**  
(See Page 4)

MAIN STORE & OFFICES  
3205 S. KINGSHIGHWAY  
★  
4558 EASTON AVE.  
1101 CHOUTEAU AVE.  
500 BELLE AVE. (ALTON)

4 BIG STORES  
||

**THRIFT'S GUARANTEE**  
Every article in this catalog is **GUARANTEED** by nationally-known manufacturers and ourselves against any defect in workmanship and material. If you are not satisfied with any merchandise bought from us, **WE WILL RETURN YOUR MONEY.**



PHONE SIDNEY 7200

# OUR NEW SUPER STORE 3205 S. KINGSHIGHWAY

PHONE  
SIDNEY  
7200

PLENTY OF "PICK-UP" SPACE FOR  
THRIFT CUSTOMERS



## FREE PARKING SPACE FOR 1000 CARS—

No tickets to get stamped! No money to be refunded if you make a purchase! THRIFT'S PARKING IS FREE whether you just "come to look" or whether you buy! Feel free to drive in at any time—stay as long as you like—we want to make your shopping pleasant as well as PROFITABLE!

## OUR POLICY . . .

It's not just luck that has earned us our fine reputation for fair dealing . . . It's not just luck that has made our steady growth possible! No, Sirree! It's the solid down to earth policy which we adopted the first day we opened our doors—the policy of giving the home owners the most for their money in down right quality and long time satisfaction!

Our determination to sell nothing but the most dependable quality merchandise . . . our ability to give you the LOWER PRICES made possible by our large scale merchandising . . . our desire to play fair with our customers and allow the home owner to buy anything he desired for the maintenance of his home at the same prices that the professional workmen enjoyed has certainly paid big dividends in customer acceptance!

Each year has seen our sales volume go higher and higher . . . each year has witnessed a steady growth in the number of home owners served . . . and now with the opening of this NEW SUPER STORE at 3205 South Kingshighway, we welcome the opportunity of serving a still greater number of people!

## NOTE THE CONVENIENT LOCATION OF THRIFT STORES . . .

Four complete Hardware and Supply Stores to serve you—3 in strategic St. Louis locations, 1 in Alton, Illinois. . . Stores that welcome the smallest home owner as well as the biggest contractor . . . stores with stocks as balanced and price right as a nation wide buying organization of plumbing, hardware and lumber specialists can make them . . . stores with stocks so complete that even in these days of shortages you can always stop in at a THRIFT store with the assurance of getting just what you need to repair or improve your home.

## REMEMBER! YOU CAN BUY ANYTHING ON THRIFT'S E-Z PAY PLAN!

We do everything in our power to make it easy, pleasant, and profitable for YOU to do business with us. You can buy for cash or on credit, just as you prefer.

But you don't have to have ready cash to make the needed repairs on your home or to improve your bathroom . . . your kitchen . . . your heating plant!

Just pick out what you need . . . give us the few points of essential information . . . and we can quickly arrange an easy payment plan that will fit your budget. In fact in many cases you can buy on—

TERMS AS  
LOW AS  
\$5 A  
MONTH!



COPR. 1948  
THRIFT HARDWARE  
& SUPPLY CO.

★  
ALL PRICES  
SUBJECT TO  
CHANGE  
WITHOUT  
NOTICE

# 3 DIFFERENT STYLES IN SCREEN DOORS!

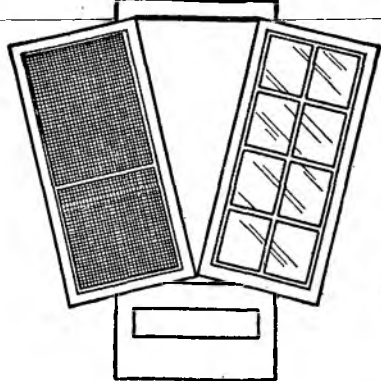

## COMBINATION STORM AND SCREEN DOORS

Think of what you get—two doors in one—no more re-handling or storing separate doors each spring and fall! No more changing hinges—simply change panels—which takes about two minutes. Then the quality—all joints are mortised, tenoned, pinned and glued. Fine quality clear glass, secured with moulded wood heads. Screen panel is wired with heavy galvanized screen wire. Frame is full 1½ in. thick of Ponderosa Pine, smoothly sanded, ready to paint.

| Storm Doors Overall Size | Our Low Price |
|--------------------------|---------------|
| 2'6" x 6'6"              | \$14.69       |
| 2'8" x 6'8"              | 14.79         |
| 2'10" x 6'10"            | 16.75         |
| 3'0" x 7'0"              | 17.55         |

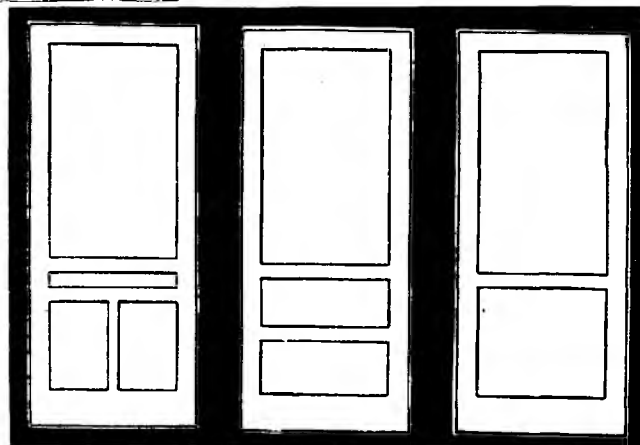

### No. 3 Galv. Screen Doors 7/8" Stained

|               |        |
|---------------|--------|
| 2'6" x 6'6"   | \$4.49 |
| 2'8" x 6'8"   | 4.69   |
| 2'10" x 6'10" | 5.05   |
| 3'0" x 7'0"   | 5.29   |

### No. 4 Galv. Screen Doors 7/8" Stained

|               |        |
|---------------|--------|
| 2'6" x 6'6"   | \$5.95 |
| 2'8" x 6'8"   | 6.25   |
| 2'10" x 6'10" | 6.65   |
| 3'0" x 7'0"   | 6.95   |

### No. 90 Special Galv. Screen Door 1 1/8" Stained

|               |        |
|---------------|--------|
| 2'6" x 6'6"   | \$6.95 |
| 2'8" x 6'8"   | 7.15   |
| 2'10" x 6'10" | 7.45   |
| 3'0" x 7'0"   | 7.65   |

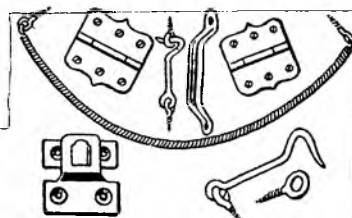

## COMPLETE SCREEN DOOR SETS

Set consists of pair of loose pin hinges, coil spring door pull, hook and eye with screws . . . All for . . . **39c**

RIM SCREEN DOOR LOCK . . . . . **89c**

MORTISE SCREEN DOOR LOCK . . . . . **98c**



## FINE QUALITY SCREEN WIRE

Full gauge, heavy duty screen wire for windows or doors . . .

FIRESTONE VALLEN (PLASTIC) WIRE, Square Foot . . . **9 1/2c**

GENUINE BRONZE WIRE, Square Foot . . . . . **12c**

## SCREEN DOOR GUARD

**\$1.69**

A very attractive wrought iron type fancy grill guard . . . will dress up your door as well as give added protection.

## SCREEN DOOR CHECKS

A simple, easily adjusted check that prevents your screen door (or storm door) from slamming shut . . . Only . . .

**\$1.49**

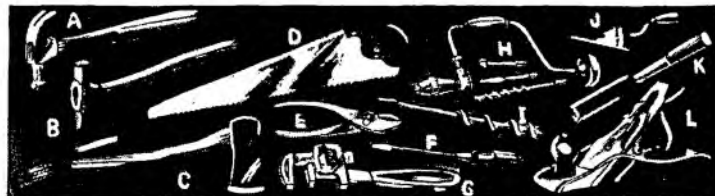
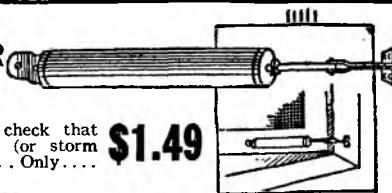

## SAVE ON EVERY-DAY TOOL NEEDS

. . . and of course you'll want tools of dependable quality even if you only use them around the house for odd jobs! At Thrift you'll find all kinds—every one guaranteed to give perfect satisfaction. We only have room to show a few.

|                     |        |
|---------------------|--------|
| Claw Hammers        | 98c    |
| Household Hatchet   | \$1.49 |
| Household Axe       | \$1.89 |
| 8 Pt. 26" Saw       | \$2.39 |
| Mechanic's Pliers   | 29c    |
| Screw Drivers       | 10c    |
| 10" Stillson Wrench | \$1.59 |
| Carpenter Brace     | \$3.49 |
| Pointing Trowels    | \$3.00 |
| Wood Chisels        | 45c    |
| 8" Smooth Plane     | \$2.98 |



## ASBESTOS ROOF COATING

Long fibre asbestos reinforcing, a blend of refined asphalt and volatile oils, make this asbestos roof coating an exceptionally fine weatherproofing protection. The tough coating forms a water-tight, weather-proof flexible blanket over the roof. It will seal cracks, joints, seams or nail holes. Easy to apply. Can also be used to line gutters, waterproof foundation and underground tanks. Simply apply it with a brush according to instructions and you need not worry about it melting in the summer or cracking and peeling in the winter. For all roofs except wooden shingles. Unusually economical . . .

|                                  |        |
|----------------------------------|--------|
| 1 gallon can at . . . . .        | \$ .69 |
| 4 gallon can at . . . . .        | 1.69   |
| 5 gallon can at . . . . .        | 2.39   |
| Roof Brush for coating . . . . . | .49    |

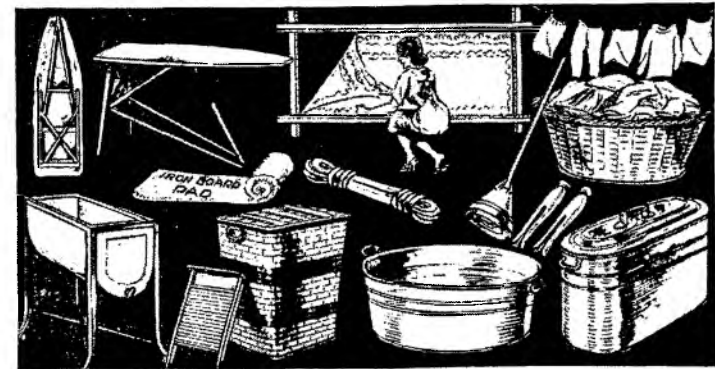

## HERE'S WASHDAY NECESSITIES AT SAVINGS!

Tubs! Boilers! Clothes Baskets! Ironing Boards! . . . Everything you'll need to make washday a success! As space is limited it is only possible to give you a bird's eye view of Thrift's immense stocks! Come in! See them for yourself!

|                                |        |
|--------------------------------|--------|
| Ironing Board at . . . . .     | \$5.95 |
| Curtain Stretcher . . . . .    | \$4.89 |
| Clothes Basket . . . . .       | \$1.98 |
| Galv. Drain Tubs . . . . .     | \$6.95 |
| Wash Board . . . . .           | \$1.19 |
| Clothes Hampers . . . . .      | \$3.95 |
| 50 Foot Clothes Line . . . . . | \$1.29 |
| Cloths Pins . . . . . Doz.     | 10c    |
| Copper Wash Boiler . . . . .   | \$8.95 |
| Galv. Wash Tubs . . . . .      | \$1.39 |

## REMEMBER!

You Can Buy Anything in This Catalog on THRIFT'S E-Z PAY PLAN! Terms as Low as \$5 a Month!

## BLACK PLASTIC CEMENT

A black asphalt cement, reinforced with asbestos fibre, about the consistency of putty. Applied with trowel or putty knife. Force it into bad cracks or holes, leaks in flashings, skylight, valleys, pipes, etc. Brush roof coating over it and you will have a permanent, elastic, leakproof repair. It will pay to use it freely.

|                       |        |
|-----------------------|--------|
| 50 lb. drum . . . . . | \$2.39 |
| 10 lb. can. . . . .   | .69    |
| 5 lb. can. . . . .    | .39    |

OUR SALESMEN ARE ALWAYS GLAD TO HELP YOU FILL YOUR NEEDS

# "IT'S FUN TO WASH UP NOW"

Kiddies and Grown-Ups Alike Enjoy  
the Convenience of a Modern Bathroom



A new bathroom means a thrill to everyone from Gran'ma to Baby Sue. No need to dwell on how much modern facilities mean to the oldsters. And as to the youngsters . . . they actually get a "kick" out of getting washed and taking a bath in a new bathroom. Why not have your new bathroom installed now?

Visit our showrooms. See complete bathrooms displayed just as they will appear in your own home.

## THE Schenley BATHROOM

3 Gleaming White Pieces, Complete with Fittings

**\$159**

COMPLETE SHOWER CAN BE INCLUDED FOR ONLY **\$17.25**



Only the highest grade materials are used in the manufacture of our bathroom fixtures. This applies not just to the surface, but also to the parts you never see. All units are finished in genuine triple-coated porcelain, to give them the hardness of flint and the sheen of a mirror. All are unconditionally guaranteed against defect of workmanship or material.

## OVER 300 BATHROOMS

Over 300 modern bathrooms can be assembled from our large varied selection of fixtures. You can be sure, then, that here you will find the exact bathroom to suit your taste . . . your purse . . . your purpose.

### THE Hastings BATHROOM

**\$139**  
COMPLETE

The lovely Hastings Bathroom includes 5-ft. built-in Tub, Spacious Lavatory in rich Colonial design, and free-standing "hush-type" Uni-Toilet. All three are complete with sparkling jewelry chrome fittings, ready to attach to your water and drainage lines. The complete Hastings Bathroom costs only . . . . . **\$139.00**



### THE Lamont BATHROOM

**\$169**  
COMPLETE

Three gleaming white pieces make up the new Lamont Bathroom . . . roomy recess Tub, 5-ft. x 30-in.; silent, free-standing Uni-Toilet; and beautiful chrome-legged Lavatory. All three are perfectly matched. The Lamont Bathroom complete with all necessary fittings in jewelry chrome is priced at only . . . . . **\$169.00**



### THE Warwick BATHROOM

**\$189**  
COMPLETE

The Warwick Luxury Bathroom is made up of 5-ft. Corner Tub (right or left corner), free-standing "hush-type" Uni-Toilet, and impressive-pedestal Lavatory. All three fixtures are equipped with non-tarnishing jewelry chrome fittings. Our low price for the complete Warwick Bathroom, . . . . . **\$189.00**



Here's the bathroom that leads the field for comfort, beauty and economy. Three beautiful, matched fixtures . . . roomy recess Tub, silent Uni-Toilet, handsome Lavatory. All are streamlined and finished in glistening triple-coated porcelain. Tub is 5 ft. long, 30 inches wide, and built in at back and both sides. Uni-Toilet is of the new free-standing design. Lavatory is impressive pedestal style . . . massive, roomy, needs no wall support. All three pieces are complete with non-tarnishing jewelry chrome fittings. The Schenley Bathroom, as illustrated and described, ready to attach to drainage and water lines, only **\$159.00**

Complete 7-way Adjusto shower (instead of over-rim tub fitting) with lovely shower curtain and chrome rod can be included for only . . . . . **\$17.25**

**EASY PAYMENTS**  
Complete Details on Page 2

### LUX-TYLE

The Luxury Tileboard for your bathroom walls

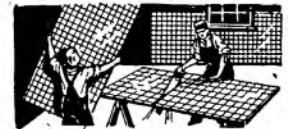

Lovely tileboard walls will add beauty to your new bathroom. Low prices and complete details elsewhere in this catalog.



THE Bedford BATHROOM  
**\$179**  
COMPLETE

The new Bedford Bathroom includes three deluxe fixtures; roomy tub for right or left corner, 5-ft. x 30 in.; chrome-legged, shelf-type lavatory; free-standing, silent-action Uni-Toilet. Complete jewelry chrome fittings are also included.

OUR Cover BATHROOM  
**\$189**  
COMPLETE

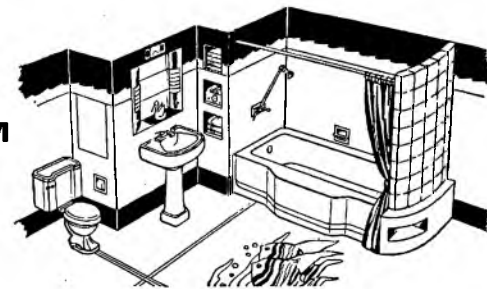

At this low price you get all three fixtures illustrated on the front cover . . . 5-ft. built-in bathtub complete with chrome Adjusto shower, plastic shower curtain, curtain pins, and chrome curtain rod; free-standing Uni-Toilet with white seat; gracefully curved pedestal style lavatory. Jewelry chrome fittings—mixing faucet, trap, strainer, supply pipes—are included too.

ASK OUR SALESMEN FOR SUGGESTIONS . . . THEY KNOW WHAT'S RIGHT!

# WAYS TO ENJOY THE ADJUSTO SHOWER

If you were willing to spend \$50 for various kinds of showers—you still could not get all the features of the ADJUSTO, the modern all-purpose shower. The ADJUSTO adapts itself to dozens of uses . . . see seven frequent ways illustrated at the right. ADJUSTO fits old or new tubs. It's instantly adjustable to any position desired. Water can be directed just where you want it, in either a gentle or a forceful spray. A half twist of the patented head gives a full solid stream of water (not a spray). This head is of the new "power" type and is self-cleaning. It actually uses 1/2 less water than old-fashioned types. The ADJUSTO is easy and economical to install. All parts are in one compact unit. Just one set of valves is needed for tub and shower combined. It is sturdily constructed of prime bronze, guaranteed for 10 years, but built to last a lifetime. Triple-plated with sparkling jewelry chrome. The ADJUSTO, with its seven uses, is on display at our store. Come in and see it. ADJUSTO shower, as illustrated and described . . . . . \$16.95

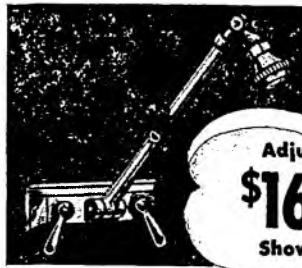

10 Year Guarantee

Adjusto Shower \$16.95



FOR CHILDREN'S BATH



FILLS THE TUB



CLEANS THE TUB



IDEAL FOR SHAMPOO



FOR A SITTING SHOWER



NO BATHING CAP NEEDED



ADJUSTABLE TO ANY HEIGHT



## MODERN BATHTUBS For Roomy, Luxury Bathing

Like modern automobiles, all bathtubs built today are good bathtubs, soundly and sturdily constructed. Our new bathtubs, however, give you more than this. They add streamlined beauty and a brand new design which makes them roomier, safer. Come in. See these modern tubs on display. We have them in every size and type.

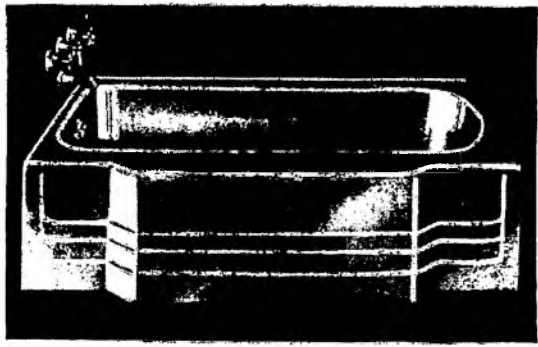

### Four-way FEATURES:

1. TUB BATH—more roomy, low and easy to enter.
2. SHOWER BATH—new flat bottom gives safer footing.
3. FOOT BATH—sit comfortably while bathing your feet.
4. DRESSING SEAT—a bathroom stool without using extra space.

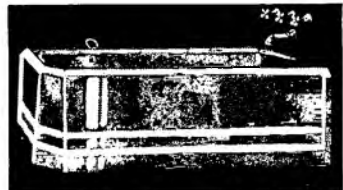

### Classic BATHTUB

Streamlined corner tub. Heavy cast iron, finished in lustrous triple-coat porcelain. 30" wide, Right or left corner. Less fittings.

5 ft. long . . . . . \$84.50

**ADDITIONAL SHOWER GOODS**  
Showers for every type of installation in old or new homes, are shown elsewhere in this catalog. Let us help you select the shower you want.

### BATHTUB FITTINGS

To give you a wider, better choice, our bathtubs are priced without fittings. Space permits us to show only the most popular fittings here. At our stores you'll find a complete selection of every type to fit your requirements.

(A) CHROME BATH FAUCET—Here is a bath faucet at a remarkably low price yet it is made of brass and finished in jewelry chrome. Complete with lock nuts. . . . . \$3.95

(B) For built-in tubs. You can temper the water to the exact degree. Brass jewelry chrome finish. . . . . \$8.95

(C) Wall fitting for built-in tubs. Bronze, with exposed parts chrome plated. Art pattern \$12.00

(D) Heavy bath faucet. Cast bronze, chrome plated. Can also be furnished with lever handles. . . . . \$6.90

(E) Supply pipe for tubs on legs or base. Complete with nuts for coupling direct to bath faucet, escutcheon. Brass, chrome plated \$1.95

(F) Comb. waste and overflow. Operated with trip lever—NO chain or rubber stopper. Brass, jewelry chrome finish. . . . . \$9.85

(G) Comb. bathtub waste and overflow, of nickel plated brass. With rubber stopper and chain. . . . . \$4.40

(H) Comb. fitting for built-in tubs. Outer handles control water supply, center handle controls shower. Heavy brass, finished in jewelry chrome. . . . . \$15.90

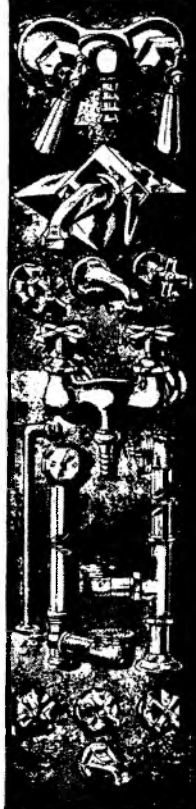

## THE Four-way BATHTUB

The Four-Way Tub, while designed to be the most practical bathtub ever built, also turned out to be the most beautiful. Its convenient seat, extends almost the entire length. Mothers find it comfortable when bathing the children. Old and young alike appreciate this ready seat while drying the body. And because of its new design, there's plenty of room to stretch out and bathe in comfort. Actually, there is as much room in the 5-foot Four-Way Tub as in oversize 5 1/2-foot ordinary tubs. Only 16 inches high—safer for elderly persons to step in and out. Made of heavy cast iron, triple-coated with snow-white porcelain—all the hardness of flint and the sheen of a mirror.

Recess pattern. Outlet on right of left. 30" wide. . . . . \$68.00  
Less fittings, 4 1/2 ft. . . . . \$69.00      5 1/2 ft. . . . . \$84.50

## SHOWER CABINETS

Complete With Curtain and All Fittings \$55.00

Here's an ideal all-steel shower cabinet for either bathroom or basement. A necessity, too, in tourist homes, cabins, factories, etc. Sturdily constructed throughout. Made of heavy gauge steel with baked white enamel finish. Has black enameled non-slip receptor. Plenty of room inside, 76"x30"x30". All accessories included: chrome plated brass shower valves; ball-joint shower head; soap dish; shower curtain; curtain rod; curtain pins; chrome plated strainer. Quickly assembled . . . you can do it yourself in less than 30 minutes. Shower can be installed on either right or left side. Complete. . . . . \$55.00

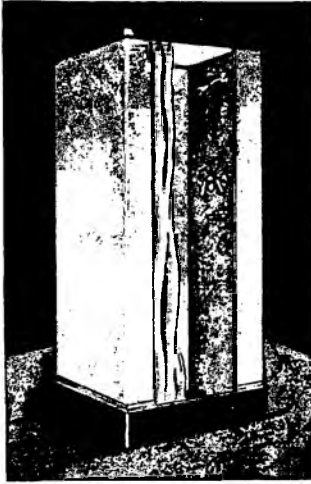

**EASY PAYMENTS**  
Complete Details on Page 2

**Electric BATHROOM HEATER \$1995**  
Built into the wall and completely out of the way. Easy to install . . . fits recess 7 1/2"x13". Fan draws cold air from floor and circulates warm air. Complete with bright chrome grille.

**Electric STEAM RADIATOR \$3600**  
Safe and convenient . . . plugs into any wall socket. Uses no more current than a modern electric iron, less than a kilowatt per hour. Ideal for bathrooms, garages, cabins, sickrooms, sun porches. Special carrying handle provided, so you can move it from room to room.

# HAVE PRICES GONE SKY-HIGH?

Not on these lovely vitreous china lavatories.  
They are only 6½% higher than before the war.

Vitreous china is still at practically the pre-war price level—one added reason why your new lavatory should be made of this time-tested material. Vitreous china has always represented the ideal in lavatory construction. Its smooth, flint-hard surface will remain lustrous for a lifetime of household service. It will not stain, rust, or change color—will not check or craze. No scrubbing, no scouring . . . just a swish with a damp cloth and a vitreous china lavatory is as brilliant and glossy as the day it was put in.



**\$11.50**

Less Fittings

## THE Economy

Though it has all the newest features, this lovely streamlined **Economy** costs no more than the most old-fashioned lavatories . . . and it's made of genuine vitreous china. New, low back fits snugly under window or medicine cabinet. Roomy bowl with anti-splash rim. Self-draining soap receptors. Size 19"x15", less fittings. . . . . **\$11.50**

## THE Sartor

Impressive pedestal styling adds to the beauty of the lovely **Sartor**. Made entirely of finest vitreous china. Has new type anti-splash basin with concealed twin overflow drain. Roomy slab for toilet articles. Less pipe and fittings. **32.30**  
24"x20". . . . .



## THE Chateau

The massive, luxurious **Chateau** will give distinction to any bathroom. Made of stainless vitreous china and mounted on twin legs. Large size permits both a roomy bowl and wide ledge area for toilet articles. Low back; concealed overflow; anti-splash rim. Select fittings from our complete stocks. **38.40**  
27"x20". . . . .



## THE Classic TWIN-LEG LAVATORY

The new **Classic** is the latest version of a dressing table lavatory in vitreous china. Trim lines and neat styling are set off by well-designed twin legs. Has large anti-splash bowl with concealed front overflow. Low ledged back will fit under window or medicine cabinet. Make your own choice of fittings at lowest prices.

Size 22"x18" . . . . . **\$22.95**  
Towel Bar . . . . . 2.65



**EASY PAYMENTS**  
Complete Details on Page 2

## THE Cameo

A "little gem" of space-saving convenience. The **Cameo** features a deep Tri-od basin; anti-splash rim; concealed overflow; low, wide shelf. Vitreous china. 20"x18", less fittings. . . . . **\$12.75**  
20" x 15", less fittings. . . . . **13.75**

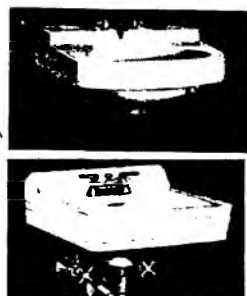

## THE Zephyr

The beautiful China **Zephyr** provides roomy ledge and all practical conveniences. Anti-splash basin. Fittings priced separately. 19"x17" . . . . . **\$16.35**

# SEE OUR COMPLETE DISPLAYS OF MODERN LAVATORIES

Only a few of our many lavatories are shown on this page. Visit our showrooms to see exactly what you want. Our selection includes all types and sizes and a wide range of price levels.

## THE Windsor

Add classical beauty to your bathroom with the impressive **Windsor**. Its graceful pedestal styling proves more popular year after year. Its bowl is

large and roomy. There's plenty of ledge space for toilet articles, too. Made of cast iron, triple-coated with porcelain. **\$39.50**  
24"x20", less fittings. . . . .

## THE Vogue

Sparkling jewelry chrome legs add distinction and charm to the new **Vogue** lavatory. Other new features include a convenient, wide shelf for toilet articles; big luxury bowl. One-piece cast iron finished in triple-coat porcelain.

19"x17", less fittings. . . . . **\$25.45**  
24"x18", less fittings. . . . . **31.25**  
Towel Bar . . . . . 2.65

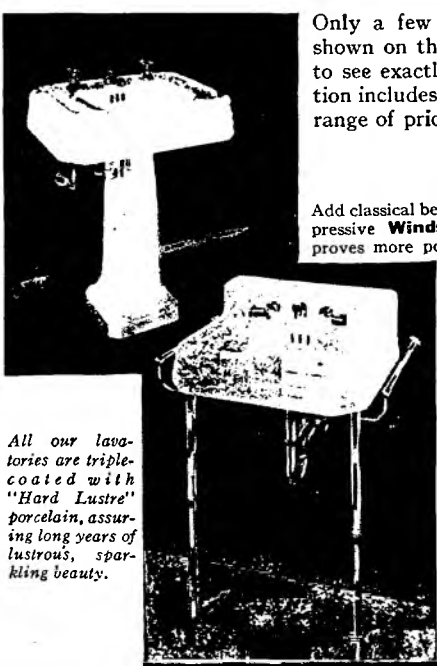

All our lavatories are triple-coated with "Hard Lustre" porcelain, assuring long years of lustrous, sparkling beauty.

## THE New Mode

Colonial design. New, low back. Deep bowl. Snow-white porcelain on cast iron. Wall hangers included. Less fittings.

19"x17" . . . . . **\$16.95**  
20"x18" . . . . . **17.50**



## THE Trend

The modern **Trend** has roomy bowl, handy top ledge, concealed front overflow. Pipe and fittings extra as selected.

19"x17" . . . . . **\$18.95**  
24"x18" . . . . . **24.75**



## THE Barton

An economical lavatory for small bathrooms. Roomy oval bowl. Anti-splash back. Less pipe and fittings.

19"x17" . . . . . **\$14.90**



Attractive bathroom fixtures promote habits of cleanliness. Your children will be glad to "wash up" at a new, glistening white lavatory.

## See Our Complete Display of Jewelry Chrome Fittings

Just a few of our many lavatory fittings can be listed here. In our stores we have on display, plainly priced, a vast selection of fittings for every taste and requirement. A complete assortment of traps, as well as additional faucets and strainers, is listed elsewhere in this catalog.

a. Lavatory Faucet. Brass, non-tarnishing chrome finish. Incl. locknut, coupling nut and tail-piece. . . . . **\$2.48**

b. Lavatory Strainer. Known as P. O. Plug. Chrome-plated brass. With chain and stopper. . . . . **98c**

c. Pop-up Waste. Eliminates chain and stopper. Controlled by knob in center. . . . . **\$5.20**

d. Lavatory Faucet. Extra heavy brass. Chrome finish. Also with lever handle. . . . . **\$2.95**

e. Single Spout Lavatory Faucet. Cast bronze. Jewelry chrome finish. . . . . **\$6.95**

f. Combination Lavatory Fitting. Center mix faucet combined with pop-up waste. . . . . **\$13.00**

g. Converter Lavatory Fitting. Single stream spout. Removable soap dish. Adjustable to any size. . . . . **\$9.90**

h. Shampoo Fitting. Valve diverts water to shampoo head when wanted. . . . . **\$14.95**

i. Wall Lavatory Supply. Brass, chrome-plated. . . . . **\$1.90**

j. Stop Valve. Straight or angle pattern. Chrome plated. . . . . **\$1.90**

k. Floor Lavatory Supply. Chrome plated brass. . . . . **\$1.90**



**VETERANS NEED HOUSING . . . MAKE A NEW APARTMENT IN YOUR HOME NOW**

# THIS DEEP WELL FAIRBANKS-MORSE EJECTOR WATER SYSTEM (READY TO PLUG IN)

Yes! This double pipe ejector pump is complete with motor . . . ejector . . . threadless coupling . . . foot valve and strainer . . . and 42 gallon tank with volume control (but without pipe).

**\$180<sup>00</sup>**

### SPECIFICATIONS

|                                       |                      |                     |                   |
|---------------------------------------|----------------------|---------------------|-------------------|
| Motor<br>¾ H.P.                       | Min. Well Size<br>4" | Suction Pipe<br>1½" | Drive Pipe<br>1¼" |
| <b>CAPACITY DOUBLE PIPE DEEP WELL</b> |                      |                     |                   |
| Water Level<br>Gallons per Hour       | 40 ft.<br>1150       | 70 ft.<br>575       | 100 ft.<br>280    |
|                                       |                      |                     | 120 ft.<br>210    |

## VITREOUS CHINA TOILETS



Only  
**\$34<sup>00</sup>**

### THE *Crescent* UNI-TOILET

has every modern feature. Sanitary stain-proof china with soiling area under water. Easy to clean with only soap and water. Quiet, economical use of ¼ less water per flushing. Flushes with swirling, scouring action. New comfortable low height.

The free-standing Crescent needs no wall support. Tank rests on bowl to form single unit eliminating unsightly flush pipes and making cleaning easier. Positive action quickly and quietly empties bowl. High quality bronze tank fittings included. Less seat . . . make your own choice from our complete selection.

### TANKS, LIDS & BOWLS

to replace all types of broken or cracked units. Other closet repair and replacement parts are shown on page 15.

## EASY PAYMENTS

Terms as Low as \$5 Month

## THE *Waldorf* TOILET

Only  
**\$32<sup>00</sup>**  
Complete

An outstanding value. Both tank and bowl are genuine vitreous china. Bowl is standard wash-down type. Price includes all tank fittings of copper or bronze and also chrome plated flush elbow. Toilet seat priced separately.

### VITREOUS CHINA WALL URINAL

For taverns, hotels, and public rest rooms. Complete with spud and integral strainer.  
18"x13" . . . . . \$15.50



### Electric CELLAR PUMP \$57

Keep your cellar dry. Protect your basement from floods and water drainage with this automatic sump pump. Working parts of heavy brass. Easy to install.

Complete . . . . . \$98.95

|                              |                 |                       |                         |
|------------------------------|-----------------|-----------------------|-------------------------|
| Cap. per<br>Hour<br>250 Gal. | Motor<br>¾ H.P. | Suction<br>Pipe<br>¾" | Discharge<br>Pipe<br>½" |
|------------------------------|-----------------|-----------------------|-------------------------|



### ★ PUMP SUPPLIES

- Foot valve and strainer (keeps pump primed).  
1¼" pipe size . . . . . \$1.10
- Drive Well Point . . . . . attach to pipe and drive to required depth . . . . .
- 30" Size at . . . . . \$2.79
- 36" Size at . . . . . \$3.45
- 42" Size at . . . . . \$3.98
- Drive well cap (protects pipe threads when driving).  
1¼" size . . . . . \$0.65
- Pump Rod of galvanized steel . . . . . \$0.15
- Per foot . . . . .
- Pump Rod Coupling. Each . . . . . \$0.15
- Pump Cup Leathers . . . . . regular sizes . . . . . priced from . . . . . \$0.25
- Pump check valve leathers . . . . . regular sizes . . . . . priced from . . . . . \$0.19
- Pump Pipe . . . . . Per Foot . . . . . \$0.29

## QUALITY TOILET SEATS



### MOTHER-OF-PEARL TOILET SEAT

Beautiful flake design. Seamless finish of heavy sheet celluloid. Will not chip, discolor, or craze. Not affected by household acids or moisture. Choice of colors. Fits any bowl . . . . . \$9.75

### SUPERIOR WHITE SEAT

This gleaming white seat will retain its original beauty for years. Will not discolor, chip, or craze. Seamless finish of sprayed white enamel. New art pattern hinge. Will fit any bowl . . . . . \$6.95



**Open Front Seat.** Solid rubber—can't split. Completely sanitary. Fits any bowl. \$6.75  
Black, less cover . . . . . \$9.90

**Colored Seats.** A wide range of colors to harmonize with almost any decorative scheme. Fits any bowl. . . . . \$8.20



**White Closet Seat.** Sprayed seamless finish. Well constructed. Complete with cover and attractive chrome hinge. Will fit any bowl . . . . . \$4.95

HAVE PLENTY  
*of*  
**WATER**

WHEN  
YOU WANT IT!  
WHERE  
YOU WANT IT!

### THESE PUMPS ARE EASY TO INSTALL!

Fairbanks-Morse Ejector Water Systems come completely assembled with all pump-to-tank fittings in place and all wiring connections complete . . . all you need to do is to connect the pump to the supply and service lines, prime, and plug in.

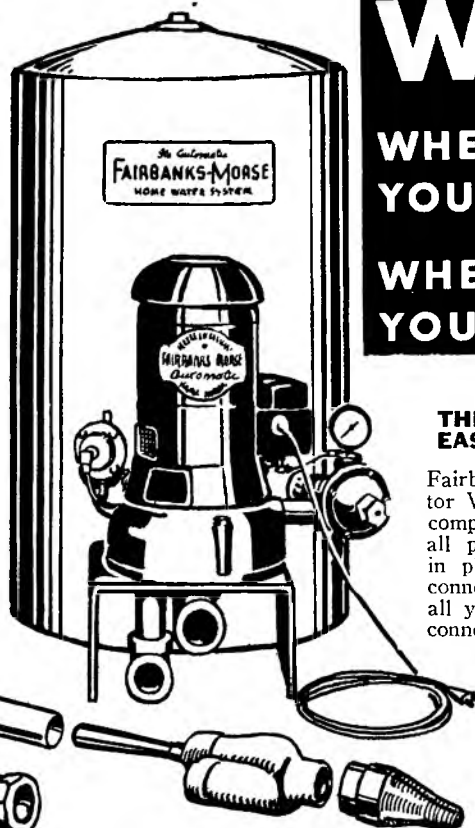

### SHALLOW WELL EJECTOR WATER SYSTEM FOR WELLS UNDER 25 FT.

# YES! PRICES ARE STILL LOW

Here's proof! More than three-fourths of the items on this page are the same price or even lower than they were five years ago.



**THE Castle CABINET**

Twin chrome-plated brackets give brilliant light for shaving, make up, or other daily toilet duties. Completely wired. On and off switch mounted on side of frame. Quality copper-sealed back, frameless, Venetian plate glass mirror. Mirror size 22"x16". Auto body steel construction. White enamel baked-on finish inside and out. Two adjustable plate glass shelves. Box 3 1/2" deep. Fits wall opening 18 3/4"x14". Razor blade drop, tooth brush holder. Complete with washers and screws to insert in wall, only. **\$22.95**

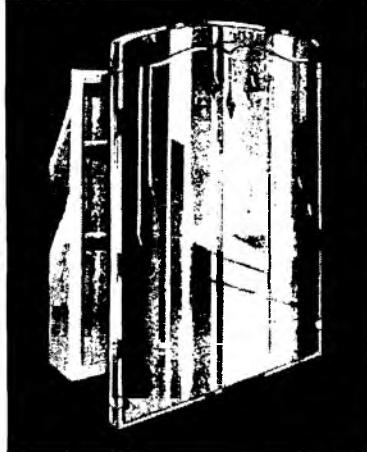

**Houston CABINET**

Beautiful framed clear-glass mirror. Mirror size 20"x14". Recess cabinet of auto body steel. White enamel finish. Two roomy shelves, tooth brush holder, razor blade drop. Piano type hinge. Box 3 1/2" deep. Fits wall opening 16 3/8"x12 1/4". Complete with screws and washers ready to insert in wall. Our low price. **\$6.95**

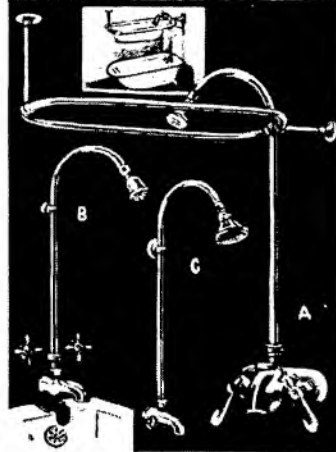

(A) **Converto Shower**. For homes where a permanent shower is desired and concealing the pipes is impossible. Diverter valve lets water flow to the shower or tub. Fastens to wall and ceiling with brackets. Large curtain ring. Adjustable water-saving head. Jewelry chrome finish. **\$29.95**  
 (B) **Overrim Converto Shower**. For recess or corner built-in tub. Attaches to wall with bracket. Easily installed. Adjustable power shower head. Jewelry chrome finish. **\$16.90**  
 (C) **Economy Converto Shower**. Replaces overrim fitting. Water can be diverted to shower or tub. Octagon head ball-joint shower. Jewelry chrome finish. **\$16.50**



**Gay Shower Curtains**

They thrive on cold splashes and steaming hot showers... won't stick, crack, or harden. Made of the latest pliable plastic. Floral, marine, and moderne designs in a wide range of colors. Full 6'x6' size. **\$5.95**

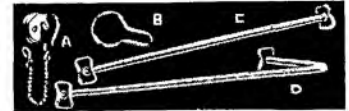

(A) **Shower Tieback**, lustrous chrome. Complete with hook, chain, and screws. **55c**  
 (B) **Curtain Pins**, rustless jewelry chrome. Dozen. **39c**  
 (C) **Straight Chrome Curtain Rods**, for 5" recess tubs. Includes flanges and screws. **\$2.95**  
 (D) **"L" Curtain Rod for Corner Tubs**. Complete for 5" tubs. Screws and flanges included. **\$5.30**

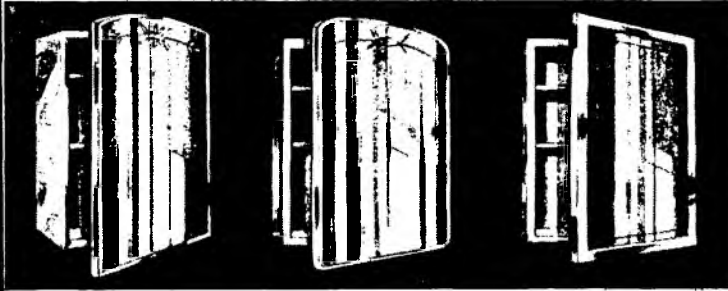

**Wall Hung CABINET**

Baked-on white enamel inside and out. Gracefully arched mirror, size 18"x11". Channel frame all around mirror provides strength and rigidity to the door. Two steel shelves, sturdy butt hinges. **\$2.98**

**Clearview CABINET**

Beautiful frameless Venetian mirror. Mirror size 22 1/4"x16 1/4". Recess cabinet of auto body steel. White enamel finish. Two roomy shelves, tooth brush holder, razor blade drop. Chain stop on door. Box 3 1/2" deep. Fits wall opening 18 1/2"x14". **\$10.50**

**Deluxe CABINET**

Recess type. Decorated plate glass mirror, size 22"x16". Auto body steel construction. Three adjustable plate glass shelves, blade drop, tooth brush holder. Piano hinge door. Box 3 1/2" deep—fits wall opening 19 3/8"x13 3/8". Only. **\$15.75**

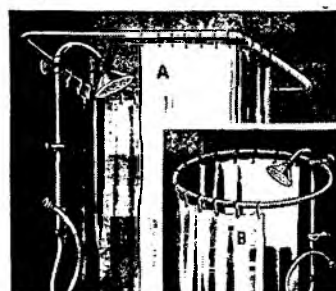

(A) **Square Portable Shower**. Fifty percent more room than round type—keeps shower curtain from clinging to your body. Rigid wall bracket at top and side easily attached to wall. Slip-on connector fits any faucet. Chrome plated brass, less curtain. **\$11.95**  
 (B) **Round Portable Shower**. A great convenience. Quickly installed to wall with two flanges. Large curtain ring. Metal parts brass, chrome plated. Less curtain. **\$6.90**

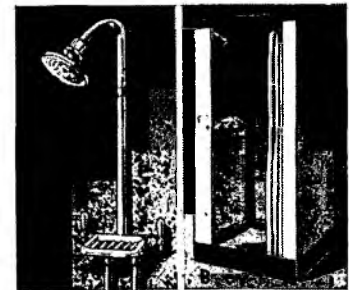

**(A) UTILITY SHOWER**

For basements or industrial use. Complete with heavy brass valve, wall bracket, riser pipe, soap dish, and adjustable swivel joint power shower head. **\$7.45**

**(B) MODERN SHOWER CABINET**

Refer to page 5 for a complete description and illustration of this popular shower cabinet. It's equally useful in tourist homes, cabins, basements, or bathrooms. See it on display at our store.

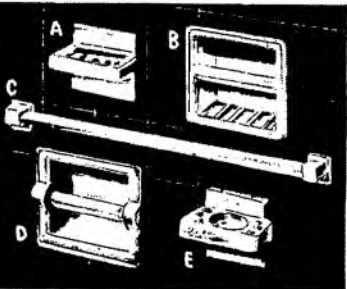

**RECESS ACCESSORIES**

Choose from either white vitreous china or lustrous jewelry chrome, these built-in accessories can be easily and quickly installed in tileboard, tile, or plain walls. Flanges cover rough joints neatly. Easy to clean, sanitary—a necessity in the modern bathroom.

|                                    | China | Chrome |
|------------------------------------|-------|--------|
| (A) Soap Holder                    | \$.95 | \$1.49 |
| (B) Soap Dish and Grab Bar         | 2.15  | 3.75   |
| (C) Towel Bar, 18"                 | 1.30  | 2.67   |
| (D) Towel Bar, 24"                 | 1.50  | 2.95   |
| (E) Tissue Holder                  | 1.65  | 3.10   |
| (F) Tooth Brush and Tumbler Holder | .95   | 1.54   |

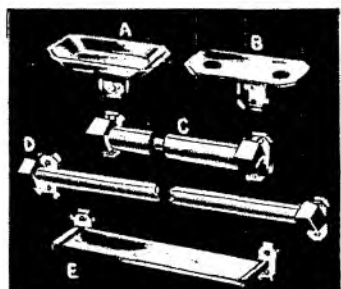

**CHROME ACCESSORIES**

Flush mounted type. Can be easily and quickly attached to any type of wall. New—Modern, these fixtures will make your bathroom sparkle. Sanitary—easy to clean—only a damp cloth needed.

|                                    |      |
|------------------------------------|------|
| (A) Soap Dish                      | 1.35 |
| (B) Tooth Brush and Tumbler Holder | 1.35 |
| (C) Paper Holder                   | 2.17 |
| (D) Towel Bar, 18"                 | 2.59 |
| (E) Towel Bar, 24"                 | 2.77 |
| (F) Glass Shelf                    | 3.49 |

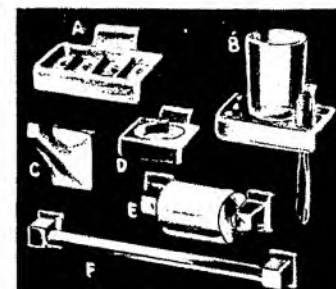

**CHINA ACCESSORIES**

Attached flush to the wall by slide fastener. It fits in the concealed groove in the back of every fixture and holds it firmly to the wall—yet completely concealed. Easy to install—rich in appearance. Will add brilliance to old or new bathrooms.

|                                    |       |
|------------------------------------|-------|
| (A) Soap Dish                      | \$.55 |
| (B) Tooth Brush and Tumbler Holder | .55   |
| (C) Robe Hook                      | .29   |
| (D) Tumbler Holder                 | .60   |
| (E) Paper Holder                   | .80   |
| (F) Towel Bar, 18"                 | 1.10  |
| (G) Towel Bar, 24"                 | 1.20  |



**(A) Stamped Brass Shower Head**, large size. **85c**

(B) **Ball-Joint Shower Head**, cast brass head and arm. Chrome finish. Includes head, bent arm swivel joint and es-cutcheon. **\$3.76**

(C) **Power Shower Head**, self-cleaning adjustable spray, cast brass, jewelry chrome finish. Includes swivel joint. **\$1.98**

(D) **Bathtub Seat**, for safety in bathing. Rubber covered hinges. White enameled wood. **\$1.70**

(E) **Bathroom Stool**. Sturdy steel stool with handsome white baked enamel finish. **\$2.95**  
 (F) **Bathroom Scales**, compact and accurate. Easily read from standing position. Rubber tread prevents slipping. Our low price. **\$5.95**

**IS TRIPLE-CHECKED. IT MUST BE "RIGHT"**

*Lux-Tyle*

THE TILE COLORED LIKE TILE!

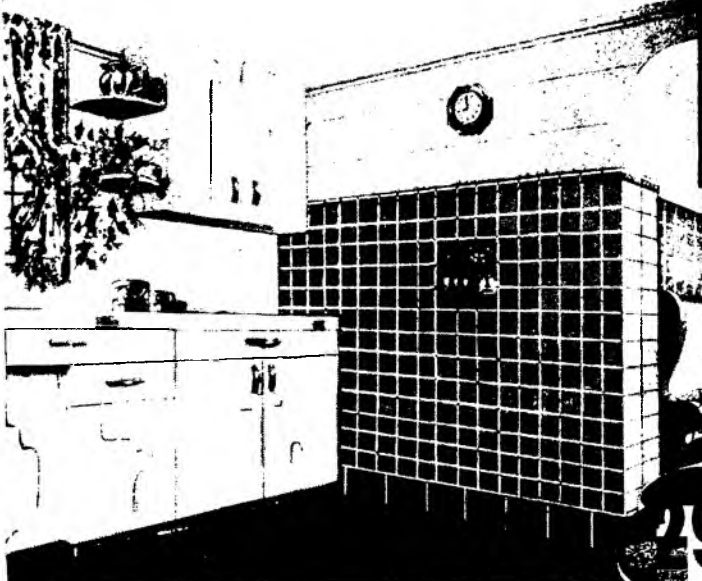

Here's the new low-cost way to give your rooms a permanently modern, colorful, sanitary wall treatment. This luxurious tileboard comes in large, easy-to-handle panels and can be used in either old or new homes. With these hard-surfaced, brilliantly beautiful, tile-like panels you can make the smartest of interiors . . . at a very low first cost and absolutely no upkeep at all. Lux-Tyle needs no periodical renovating. Once applied, your decorating problem is solved permanently.



**29c** Sq. Ft.  
4' Panel



**BRIGHT TONED ALUMINUM TILE . . . .**  
**45c** Sq. Foot

So new! So practical! So beautiful! And it looks like the finest of glazed tile yet it won't crack or chip! So easy to install—almost anyone can do it—and at 45c a square foot it's so inexpensive. 7 different colors!



**LINOLEUM TILE**  
**59c** Lineal Ft.

This 54" wide linoleum tile makes a bathroom or kitchen that is so easy to keep clean—as easy as the linoleum on your floor! . . . and it's so easy to put it on the wall with cement . . . Economical, too, as the price is only 59c a lineal foot.

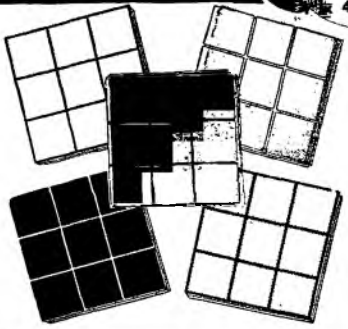

**BRILLIANT ARRAY OF GLORIOUS COLORS**

Most popular for bathrooms and kitchens are the panels scored in tile-like squares—in alluring tile colors. These luxurious colors and patterns can be combined to give you unrestricted freedom in color-planning your rooms. The parallel and streamlined scorings are especially effective for large rooms. Then there are the lustrous plain panels in every conceivable color. Limited space does not permit a listing of the glorious variety of patterns and colors. Visit our store, see this colorful tileboard displayed as it will actually appear in your own home.

**NO DIRT, NO MUSS WITH *Lux-Tyle***

Previously, the desire for tile walls in bathrooms, kitchens, or any other room brought forth a mental picture of anguish, expense, days and days of fuss and muss with workmen—stumbling over piles of materials. NOW, with TILE-BOARD, this mental picture dissolves. The application is so easy that you can actually do a splendid job of installing it yourself. You need only a sound wall structure, fairly smooth; age of the building is not an important factor. Our skilled workmen can move in on the job and quickly apply this lovely tile-like board over your present walls. No debris of plaster or mortar. The use of the room is not even disturbed.

***Lux-Tyle* IS EASY TO CLEAN**

As easy to keep sparkling as a china dish—simply wash it with warm water and a soft cloth. Where stubborn stains remain, use any good non-alkali or non-abrasive soap. This luxurious wall covering is proof against all vermin that thrive in partitions. Its glorious surface is not affected by any of the elements that tend to destroy ordinary wall finishes under normal use, such as heat, water, or steam.

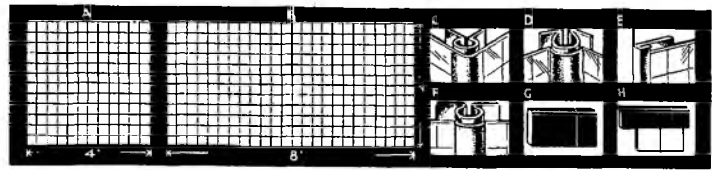

**EXTRA FINE DURO-TILE**

BIG 4'x4' PANELS IN WHITE AND COLORS **35c** SO. FOOT

**TILEBOARD SUPPLIES**

- Adhesive Cement, qt. . . . . **90c**
- Adhesive Cement, gal. . . . . **\$2.65**
- Touch-up Kit, includes enamel and brush, bottle. . . . . **20c**

**LUSTROUS METAL MOLDINGS**

- (C) Outside Corners, per ft. . . . . **24c**
- (D) Inside Corners, per ft. . . . . **24c**
- (E) End Bars, per ft. . . . . **24c**
- (F) Panel Molding, ft. . . . . **24c**

**BLACK TILEBOARD MOLDINGS**

- (G) Base Molding, per ft. . . . . **29c**
- (H) Cap Molding, per ft. . . . . **23c**

**BATHTUB MOLDING:** Makes possible a perfect installation of tileboard around any built-in bathtub. Complete set. . . . . **\$4.95**

*Lux-Tyle*

**Makes Any Room Livable**



. . . for dens, game rooms, or libraries—economical to install. Needs no periodical renovating.



**ASPHALT TILE**

**MAKE BEAUTIFUL FLOORS**

**15c** Sq. Foot

The ideal floor for homes . . . easily cleaned . . . easily installed . . . comes in 9"x9" blocks that can be varied in design . . . various dark shades to choose from!

**BRIGHT COLORS 21c SQ. FT.**

**Now . . . USE OUR EASY PAYMENT PLAN**

(Details Page 2)

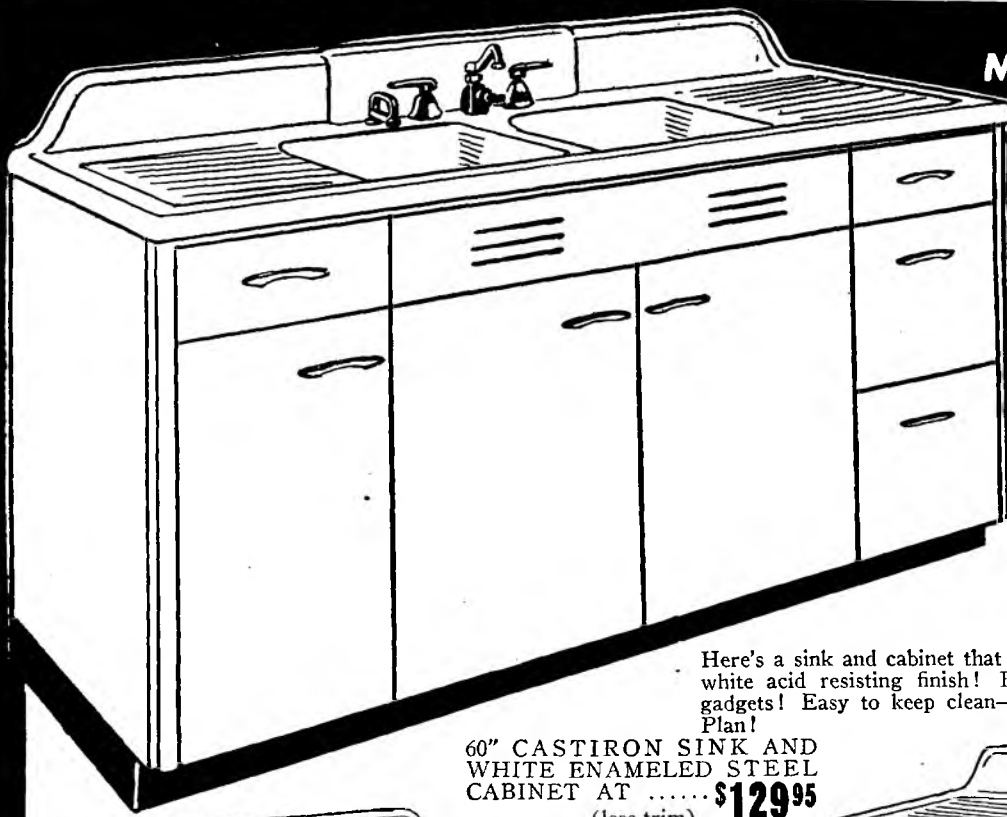

**MODERNIZE YOUR  
KITCHEN WITH  
"STEPSAVER"  
CABINET  
SINKS!**

66" DOUBLE WELL . . . DOUBLE  
DRAIN BOARD CAST IRON SINK  
AND WHITE ENAMELED STEEL  
CABINET

**\$174<sup>95</sup>** (less trim)

Here's a sink and cabinet that will delight the heart of any woman! Sparkling white acid resisting finish! Extra big with lots of room for those kitchen gadgets! Easy to keep clean—easy to use—easy to buy on Thrift's E-Z Pay Plan!

60" CAST IRON SINK AND  
WHITE ENAMELED STEEL  
CABINET AT . . . . . **\$129<sup>95</sup>**  
(less trim)

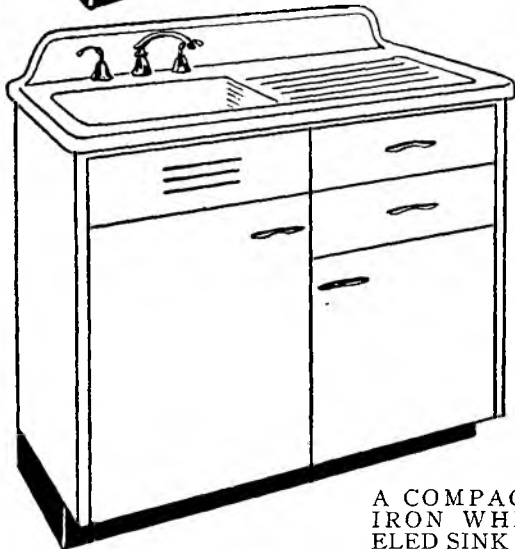

**\$69<sup>95</sup>**

A COMPACT 42" CAST  
IRON WHITE ENAM-  
ELED SINK AND GLEAM-

ING WHITE STEEL CABINET that is designed for the smaller kitchen where every foot of space must be put to work. It has everything that the large models have except size . . . in fact it's a model of efficiency as well as a beauty in appearance. It's priced at only . . . . . **\$69.95**  
(less trim)

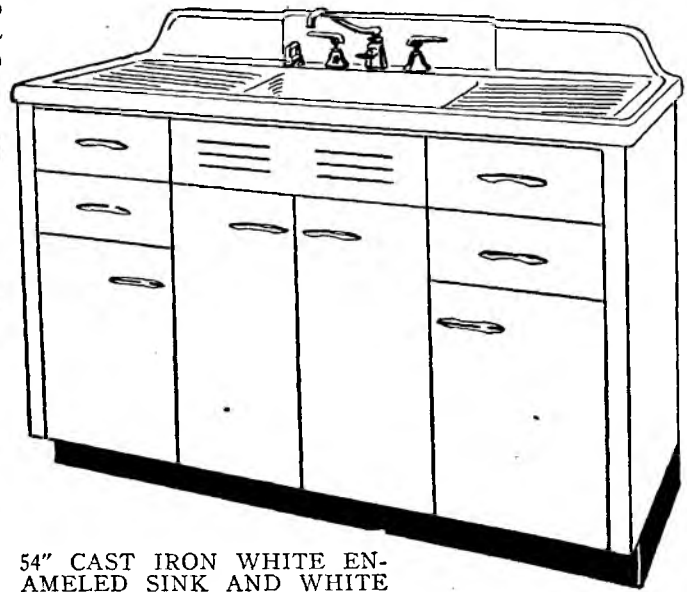

**\$98<sup>95</sup>**

54" CAST IRON WHITE EN-  
AMELED SINK AND WHITE  
STEEL CABINET . . . that is

planned to save you lots of steps—give you lots of space . . . the double drain board white enameled sink is acid resisting . . . and the low back enables you to place it under the modern windows . . . the cabinets are of heavy welded steel with easy moving drawers and lots of shelf space . . . a real bargain at . **\$98.95**  
(less trim)

**BUILD YOUR OWN  
CABINET SINK**

—with one of these low cost flat rim sinks you can build the size cabinet you want and save money, too!

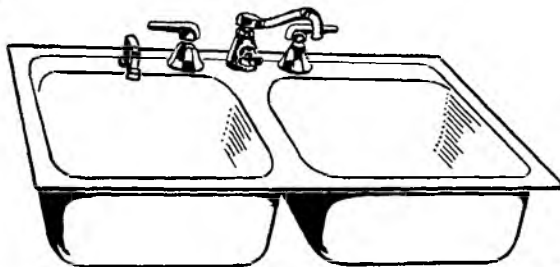

21"x32" Cast Iron Double Pan Flat Rim Sink. **\$31.80**  
(less trim)

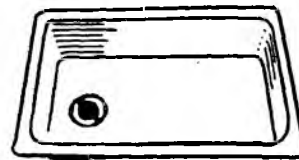

PORCELAIN ENAMELED  
STEEL FLAT RIM SINKS  
14"x20" . . . . . **\$3.95**  
(less trim)  
16"x24" . . . . . **\$4.95**  
(less trim)  
18"x30" . . . . . **\$6.95**  
(less trim)

Both of these flat rim sinks are covered with a triple coat of hard luster acid resisting porcelain enamel . . . and come with the deep bowls that housewives appreciate.

**Dozens of Different  
Kitchen Combinations  
Can Be Assembled  
From Our Large Stocks  
of Kitchen Sinks  
and Cabinets**

★ Come in —  
See Our Model Dis-  
plays for Suggestions

# ALL TYPES OF STEEL WALL CABINETS

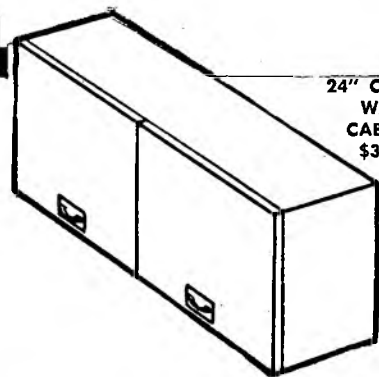
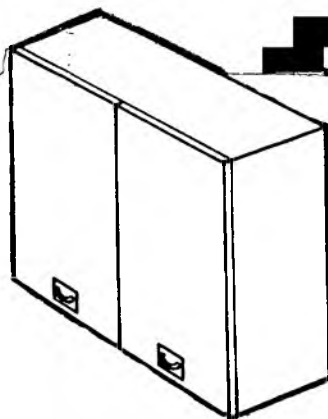
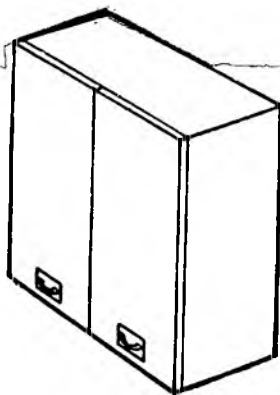
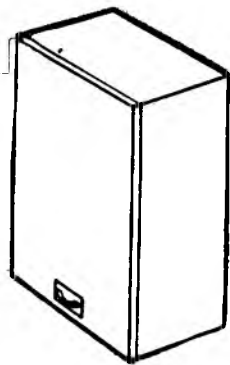

24" CORNER WALL CABINET \$33.95

Wall Cabinets 15" wide and 30" high (right or left hand door) at **\$18.95**

Wall Cabinets 18" wide and 30" high (right or left hand door) at **\$21.95**

Wall Cabinets 24" wide and 30" high . . . 2 doors . . . at **\$23.45**

Wall Cabinets 30" wide and 30" high . . . 2 doors . . . at **\$25.45**

Wall Cabinets (2 door) 18" high  
24" long at **\$21.45**  
30" long at **\$22.95**  
36" long at **\$24.95**

8 different sizes of WALL CABINETS designed to give you extreme flexibility in kitchen arrangement. . . Use them in any combination you desire and they fit in harmoniously with each other. . . Manufactured of heavy gauge welded steel that is protected by BONDERITE to resist rust and give longer life . . . finished with DuPont Delux gleaming white porcelain enamel that gives them everlasting beauty! See them—that's all we ask!



**COLORFUL PLASTIC PULL PLATES**

**29c**

They provide extra color and cheer for your kitchen as well as protecting finish against marring or scratching . . . black, yellow, blue, and red colors.

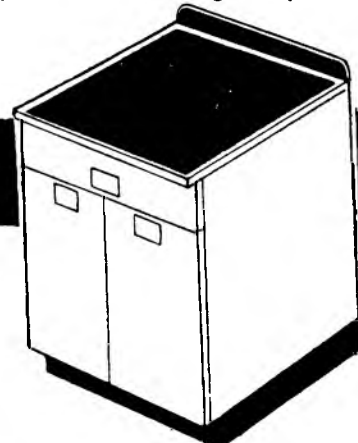
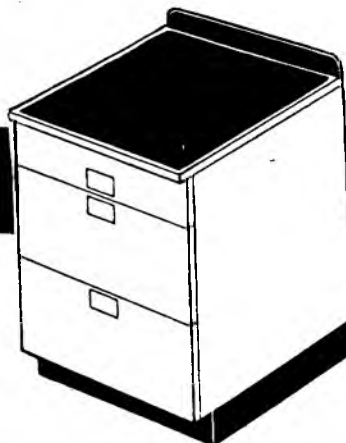
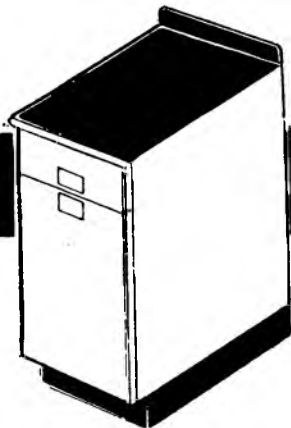

## ALL METAL BASES WITH FORMICA TOPS!

(Can be bought with or without tops)

A welcome addition to any kitchen . . . use them in the kitchen ensemble to give you added work and storage space . . . manufactured of heavy-gauge welded steel with ball bearing drawer slides and perfect fitting doors and drawers . . . Bonderized to resist rust and finished with white DuPont Dulux . . . colorful formica tops that are extremely durable.

### STEEL BASE CABINETS (Tops Extra)

|   |                |
|---|----------------|
| 15" wide — 1 drawer — 1 right or left hand door . . . . . | <b>\$26.95</b> |
| 18" wide — 1 drawer — 1 right or left hand door . . . . . | <b>\$28.95</b> |
| 24" wide — 1 drawer — 2 doors . . . . .                   | <b>\$37.95</b> |
| 15" wide — 3 drawers . . . . .                            | <b>\$29.95</b> |

### Formica Tops with 4" backs

|                       |                |
|-----------------------|----------------|
| 15" tops at . . . . . | <b>\$15.95</b> |
| 18" tops at . . . . . | <b>\$17.95</b> |
| 24" tops at . . . . . | <b>\$19.95</b> |

Choice of white . . . mother of pearl . . . or red shades.

## WHITE ENAMELED STEEL SINKS WITH FORMICA TOPS!



They're the Smartest Sinks and Cabinets Imaginable!

### Our Salesmen

are friendly, competent, trained men, capable of giving you complete advice on any plumbing, electrical or home problem and will show you the simplest way to do your job.

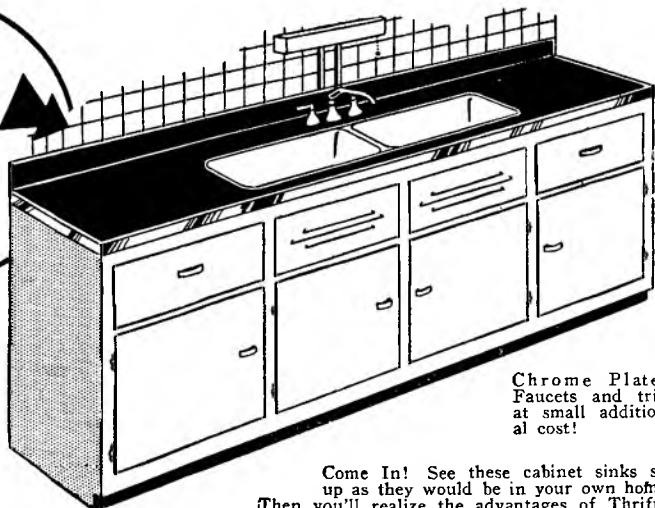

Chrome Plated Faucets and trim at small additional cost!

Come In! See these cabinet sinks set up as they would be in your own home. Then you'll realize the advantages of Thrift's formica top sinks and steel cabinets.

One of the most practical sink and cabinet arrangements on the market today. . . Formica won't crack, discolor, scratch, or burn and the colorful shades add a welcome touch to the kitchen.

|   |                 |
|---|-----------------|
| 42" Formica top sink and white all steel cabinet at . . . . .   | <b>\$69.95</b>  |
| 54" Formica top sink and white all steel cabinet at . . . . .   | <b>\$98.95</b>  |
| 60" Formica top sink and white all steel cabinet at . . . . .   | <b>\$129.95</b> |
| 72" Formica top double bowl sink and steel cabinet at . . . . . | <b>\$178.50</b> |
| 84" Formica top double bowl sink and steel cabinet at . . . . . | <b>\$202.50</b> |
| 96" Formica top double bowl sink and steel cabinet at . . . . . | <b>\$244.50</b> |

# AUTOMATIC GAS HOT WATER HEATERS

20 Gallon . . . \$59.95  
 30 Gallon . . . \$69.95  
 40 Gallon . . . \$99.50

A streamlined thermostat controlled automatic water heater that guarantees you plenty of hot water twenty-four hours a day! Has improved type bunsen burner with safety pilot control that automatically shuts off if gas goes out . . . extra heavy fiber-glass insulation prevents heat loss.

20 Gal. Automatic Tank for BUTANE GAS..... \$64<sup>95</sup> 30 Gal. Automatic Tank for BUTANE GAS..... \$74<sup>95</sup>

**PLENTY**  
*of* **HOT**  
**WATER**  
 -AT THE TURN  
 OF A FAUCET

## We Pay Full Cost of Standard Installation of ELECTRIC WATER HEATERS

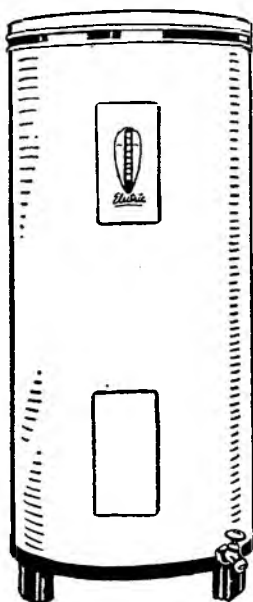
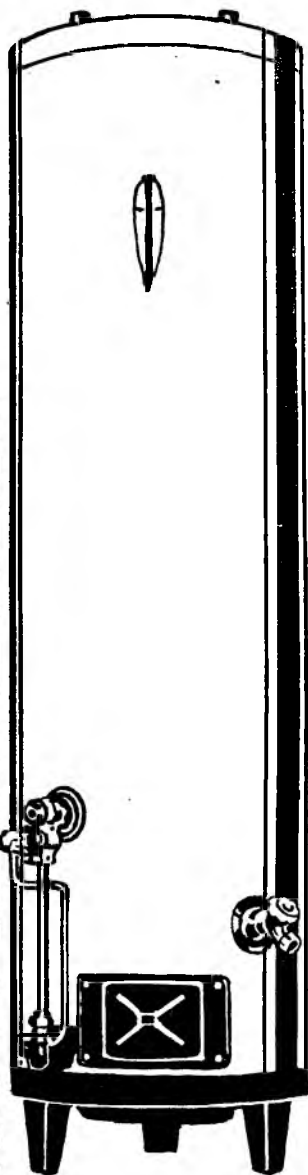

**BRADFORD  
 ELECTRIC  
 AUTOMATIC  
 WATER HEATER**

52 Gallon  
**\$119<sup>95</sup>**

82 Gallon  
**\$159<sup>95</sup>**

Completely automatic with 3" fiber-glass insulation . . . New, long life heating element is immersion type Chromolox . . . Precision welded tank tested to 300 pounds pressure . . . Standard 230 volts A.C.

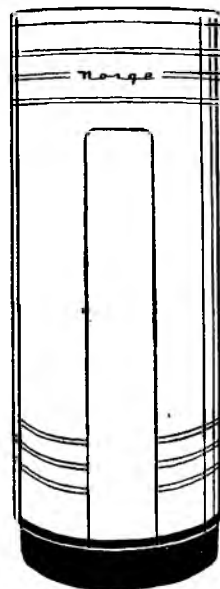

**NORGE  
 ELECTRIC  
 AUTOMATIC  
 WATER HEATER**

30 Gallon \$114.95  
 40 Gallon \$123.95  
 52 Gallon \$133.95  
 66 Gallon \$159.95  
 82 Gallon \$179.95

A vertical type Electric Water Heater with the new "NICHROME" direct contact heating element . . . heavy fiber-glass insulation . . . economical heat trap holds the supply of hot water for a long period.

**BOTH HEATERS APPROVED BY UNION ELECTRIC CO. FOR NEW RATES**

### MODERN LAUNDRY TRAYS TO MAKE YOUR WASHDAYS EASIER

*New Shelf Laundry Tray*  
 The Tray with ALL \$22<sup>00</sup>  
 the Latest Features

This newly designed laundry tray has a handy shelf-back that extends over its entire length. This built-in shelf provides a convenient place for all your soaps, powders, cleansing fluids, etc. on washdays . . . right where you can get them when you need them. Tray itself is unit-cast of finest hydraulic cement, seamless and free of rough joints. Interior finish is absolutely smooth . . . will not absorb dirt. Entire unit is reinforced with steel rods. Improved metal rim is perfectly smooth—no rough edges. Metal washboard is built right into the tray. Also has built-in, self-draining soap dish. Less stand and fittings.

**STONEWARE  
 LAUNDRY TRAYS**

**\$16<sup>35</sup>**

Sturdy double compartment trays cast in onepiece over a framework of steel rods. Size 48" x 24" Price includes metal guards, stoppers, and twin waste connection. Stand and fittings priced separately.



*Other styles and types of laundry trays are displayed at our store. See them all.*

**GAS LAUNDRY STOVES**  
**\$7<sup>95</sup>**

Sturdily constructed. Steel shelf and legs. Black enamel finish. Efficient, trouble-free burners.

#### LAUNDRY TRAY FITTINGS

(A) **Swing Spout Laundry Faucet.** Solid brass. Threaded for hose. Includes clamps and unions. \$4.25

(B) **Ledge Type Laundry Faucet.** New angle throw swing spout. Hose thread. Nickel-plated brass. Each. . . . \$5.75

(C) **Laundry Tray Trap.** Wall type. Brass, with swivel, cast outlet. 1 1/2" size. . . \$2.30

(D) **Laundry Tray Stand.** Sturdy angle steel stand. For 2 part tray. . . . \$2.70



**Save a Penny's Difference Between These CATALOG PRICES and our STORE PRICES**

# SAVE ON WINDOW SASH ... FRAMES!

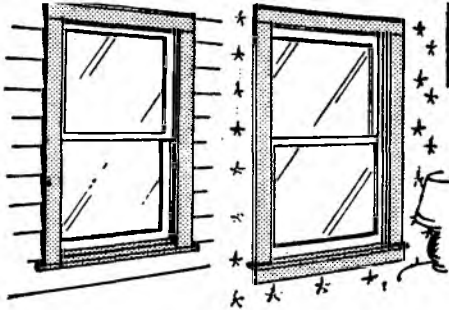

## WINDOW FRAMES FOR FRAME BUILDINGS

Comes complete K. D. . . . ready to set up on old or new houses . . . for walls 5 1/4" and 2 x 4" studding.

| Opening Size | Glass Size | THRIFT'S PRICE |
|--------------|------------|----------------|
| 2'0" x 3'10" | 20" x 20"  | <b>\$7.39</b>  |
| 2'4" x 3'10" | 24" x 20"  | <b>7.49</b>    |
| 2'4" x 4'6"  | 24" x 24"  | <b>7.75</b>    |
| 2'8" x 4'6"  | 28" x 24"  | <b>7.95</b>    |
| 2'10" x 4'6" | 30" x 24"  | <b>8.49</b>    |

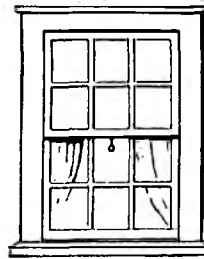

## DISTINCTIVE 6 OVER 6 LIGHT WINDOWS

| Opening Size | Glass Size | THRIFT'S LOW PRICE |
|--------------|------------|--------------------|
| 2'4" x 3'10" | 8" x 10"   | <b>\$5.49</b>      |
| 2'4" x 4'6"  | 8" x 12"   | <b>5.70</b>        |
| 2'8" x 4'6"  | 9" x 12"   | <b>6.31</b>        |
| 2'10" x 4'6" | 10" x 12"  | <b>6.85</b>        |

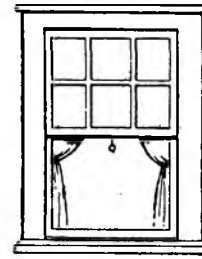

## CHARMING 6 OVER 1 LIGHT WINDOWS

| Opening Size | Glass Size | THRIFT'S LOW PRICE |
|--------------|------------|--------------------|
| 2'0" x 3'10" | 20" x 20"  | <b>\$4.95</b>      |
| 2'4" x 3'10" | 24" x 20"  | <b>5.25</b>        |
| 2'4" x 4'6"  | 24" x 24"  | <b>5.45</b>        |
| 2'8" x 4'6"  | 28" x 24"  | <b>5.95</b>        |
| 2'10" x 4'6" | 30" x 24"  | <b>6.55</b>        |

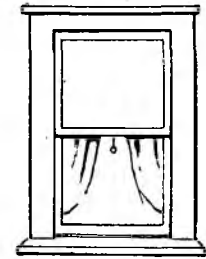

## POPULAR 2 LIGHT WINDOWS

| Opening Size | Glass Size | THRIFT'S LOW PRICE |
|--------------|------------|--------------------|
| 2'0" x 3'10" | 20" x 20"  | <b>\$3.49</b>      |
| 2'4" x 3'10" | 24" x 20"  | <b>4.49</b>        |
| 2'4" x 4'6"  | 24" x 24"  | <b>4.95</b>        |
| 2'8" x 4'6"  | 28" x 24"  | <b>5.49</b>        |
| 2'10" x 4'6" | 30" x 24"  | <b>5.95</b>        |

Now you can replace rotted window sash and frames easily and inexpensively.

## WINDOW FRAMES FOR BRICK BUILDINGS

The proper size for 9" brick walls . . .

| Opening Size | Glass Size | THRIFT'S PRICE |
|--------------|------------|----------------|
| 2'0" x 3'10" | 20" x 20"  | <b>\$7.19</b>  |
| 2'4" x 3'10" | 24" x 20"  | <b>7.29</b>    |
| 2'4" x 4'6"  | 24" x 24"  | <b>7.55</b>    |
| 2'8" x 4'6"  | 28" x 24"  | <b>7.75</b>    |
| 2'10" x 4'6" | 30" x 24"  | <b>8.19</b>    |

Measure the opening size required for the window in feet and inches—width first. Rough wall opening should be about 6 inches wider and 5 inches higher than the frame opening size to allow space for sash weights and squaring up.

## BARN SASH

Made of seasoned pine, smoothly sanded . . . with every joint mortised, tendon joined and pinned to withstand changes of temperature.

| Opening Size | Glass Size     | THRIFT'S LOW PRICE |
|--------------|----------------|--------------------|
| 1'8" x 2'1"  | 4 Lt. 8" x 10" | <b>\$2.39</b>      |
| 1'8" x 2'5"  | 4 Lt. 9" x 12" | <b>2.79</b>        |
| 2'4" x 2'1"  | 6 Lt. 8" x 10" | <b>3.15</b>        |
| 2'7" x 2'5"  | 6 Lt. 9" x 12" | <b>3.59</b>        |

# DOORS AND FRAMES FOR EVERY NEED!

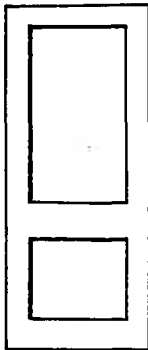

A Modern TWO PANEL FIR DOOR that is widely used in new homes and for replacement . . . smoothly sanded, ready for stain and varnish . . . all doors 1 3/8 inches. . .

|             |               |
|-------------|---------------|
| 2'0" x 6'8" | <b>\$9.95</b> |
| 2'4" x 6'8" | <b>10.95</b>  |
| 2'6" x 6'8" | <b>11.95</b>  |
| 2'8" x 6'8" | <b>12.49</b>  |

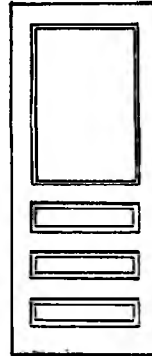

Another modern 1 3/8" Fir Door with one light and 3 cross panels . . . a door that is used in many homes because of its simplicity, plain beauty and economical price . . . stains and varnishes to a splendid finish. . . Note these prices.—

|             |                |
|-------------|----------------|
| 2'6" x 6'8" | <b>\$10.95</b> |
| 2'8" x 6'8" | <b>11.95</b>   |

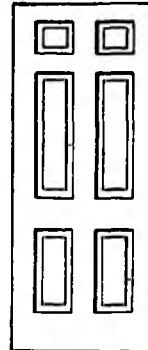

A 6 PANEL FIR DOOR that is a favorite all over America . . . built with hardwood dowel pins at corners . . . and cross rails to insure greater strength . . . stains and varnishes to a beautiful finish that shows the natural grain of the wood.

|               |                |
|---------------|----------------|
| 2'0" x 6'8"   | <b>\$ 9.79</b> |
| 2'4" x 6'8"   | <b>9.89</b>    |
| 2'6" x 6'8"   | <b>9.95</b>    |
| 2'8" x 6'8"   | <b>10.89</b>   |
| 2'10" x 6'10" | <b>11.95</b>   |



## DOOR TRIMS

Choice clear, Southern Pine, smooth figured grains—for beauty. Cut to lengths with a liberal allowance for fitting on the job. Each set included: head and side casings, any size up to and including 3'-0" x 7'-0". **\$1.29** Our Low Price

Always order two sets of trim for inside doors, one for each side. Order one set for outside doors.

## DOOR JAMBS

Head jambs fit perfectly into side jambs, which are dadoed. Surfaced and smooth sanded, ready for finishing . . . double rabbited. . . All standard sizes. Our Low Price

**\$5.95**

## DOOR AND WINDOW HARDWARE

- ★ RIM LOCKS.....\$ 1.29
- ★ MORTISE LOCK SETS. 1.39
- ★ TUBULAR DEXTER LOCK SETS..... 2.29
- ★ BIT KEY FRONT DOOR SETS..... 4.89
- ★ CYLINDER KNOB FRONT DOOR SETS.. 11.95
- ★ CYLINDER HANDLE FRONT DOOR SETS.. 12.95
- ★ 3 1/2" x 3 1/2" D.B. BUTTS. .48
- ★ 4" x 4" D.B. BUTTS.... .65
- ★ MORTISE TYPE NIGHT LATCH..... 1.98
- ★ SURFACE TYPE NIGHT LATCH..... 1.39
- ★ MORTISE DEAD BOLT 1.98
- ★ SASH LOCKS..... .09
- ★ SASH LIFTS..... .09

## IT'S EASY TO REPLACE YOUR GARAGE DOORS

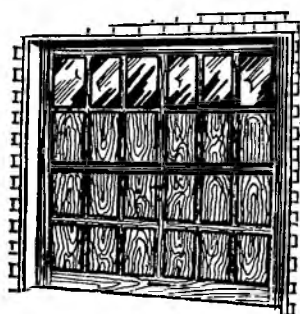
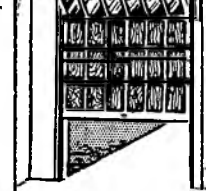



**4 SECTION OVERHEAD GARAGE DOORS..... COMPLETE**

**\$69.95**

The practical 8'x 7' trouble free, weather resistant garage door that is very economically priced. Complete with hardware at \$69.95.

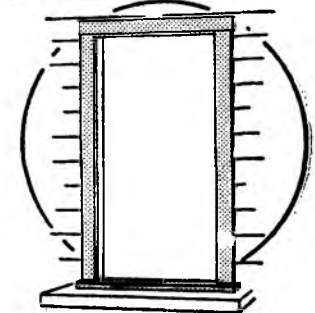
**OVERHEAD GARAGE DOOR HARDWARE (Make your own door) \$21.95**



## FRAMES FOR EVERY DOOR

First quality clear pine. For frame houses with 2 x 4 in. studding and 5 1/4 in. walls, or brick building with 9 in. walls. . . Comes complete K. D. ready to setup on old or new houses. Sizes 2-6 x 6-8, to 3-0 x 7-0. **\$9.65** all at one low price. . . . .

**Buy Anything in this Catalogue on Thrift's E-Z Pay Plan**

# 4 BIG THRIFT LUMBER YARDS TO SERVE YOU!

Just Call  
Sidney 7200

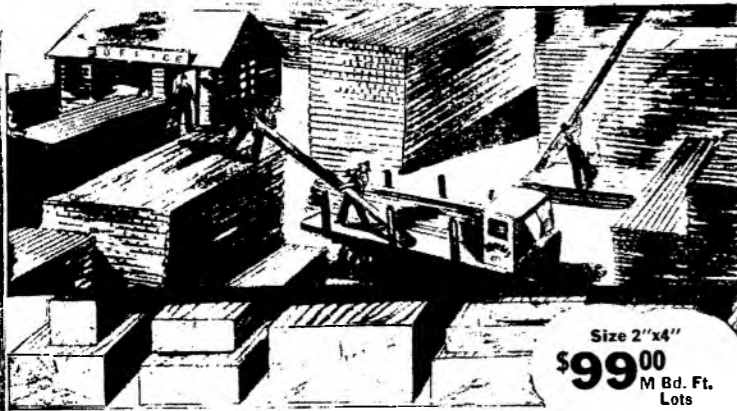

Size 2"x4"  
**\$99.00**  
M Bd. Ft.  
Lots

Everything You Need for Your Job. Joists, Studding, Framing, Shingles, Clapboards.

Our lumber comes from the largest and most reliable mills in the country. Every piece is carefully graded according to the standards adopted by the Lumberman's Association and in accordance with the U. S. Bureau of Standards' Specifications. Every piece passes the rigid test of quality before leaving our yards.

### FRAMING AND DIMENSION LUMBER

Just a partial group of the best selling sizes and grades. Our yards are completely stocked with all grades in all sizes, for the smallest repair job, to the largest new building. Send us a rough sketch of what you have in mind together with full information. Hundreds of home-owners have been helped by our building experts, and save many dollars and lots of worry.

#### NO. 2 AND BETTER YELLOW PINE S4S

| Size | Quantity Per 1000 | 8 Ft. Lgth. | 10 Ft. Lgth. | 12 Ft. Lgth. | 14 Ft. Lgth. | 16 Ft. Lgth. | 18 Ft. Lgth. | 20 Ft. Lgth. |
|------|-------------------|-------------|--------------|--------------|--------------|--------------|--------------|--------------|
| 2x2  | \$ 99.00          | .26         | .33          | .40          | .46          | .57          | .64          | .71          |
| 2x4  | \$ 196.50         | .53         | .66          | .79          | .92          | 1.14         | 1.28         | 1.42         |
| 2x6  | \$ 393.00         | .80         | 1.00         | 1.19         | 1.39         | 1.70         | 1.92         | 2.13         |
| 2x8  | \$ 589.50         | 1.06        | 1.33         | 1.59         | 1.89         | 2.27         | 2.56         | 2.84         |
| 2x10 | \$ 786.00         | 1.42        | 1.78         | 2.13         | 2.49         | 2.92         | 3.29         | 3.65         |
| 2x12 | \$ 982.50         | 1.86        | 2.33         | 2.80         | 3.26         | 4.05         | 4.55         | 5.06         |

#### NO. 2 AND BETTER FIR AND HEMLOCK

| Size | Quantity Per 1000 | 8 Ft. Lgth. | 10 Ft. Lgth. | 12 Ft. Lgth. | 14 Ft. Lgth. | 16 Ft. Lgth. | 18 Ft. Lgth. | 20 Ft. Lgth. |
|------|-------------------|-------------|--------------|--------------|--------------|--------------|--------------|--------------|
| 2x4  | \$122.00          | .65         | .81          | .98          | 1.14         | 1.37         | 1.54         | 1.71         |
| 2x6  | \$244.00          | .98         | 1.22         | 1.46         | 1.71         | 2.14         | 2.41         | 2.68         |
| 2x8  | \$366.00          | 1.30        | 1.63         | 1.95         | 2.28         | 2.86         | 3.22         | 3.57         |
| 2x10 | \$488.00          | 1.67        | 2.08         | 2.50         | 2.92         | 3.65         | 4.11         | 4.57         |
| 2x12 | \$610.00          | 2.03        | 2.54         | 3.05         | 3.56         | 4.46         | 5.02         | 5.58         |



### SMOOTH, TRUE-TO-SIZE LUMBER

Only the higher grades of Fir and Yellow Pine are selected at the sawmill for our finishing lumber. This selected material is then piled out in the open for "air" seasoning. After months, or perhaps even a year, it is brought into dry kilns. After days of mellowing, it is then ready to be surfaced four sides and stored in covered sheds. The finished product gives you easy-to-work lumber that won't curl, buckle or shrink—and stands the weather.

#### NO. 2 AND BETTER YELLOW PINE S4S

| Size | Quantity Per 1000 | 8 Ft. Lgth. | 10 Ft. Lgth. | 12 Ft. Lgth. | 14 Ft. Lgth. | 16 Ft. Lgth. | 18 Ft. Lgth. | 20 Ft. Lgth. |
|------|-------------------|-------------|--------------|--------------|--------------|--------------|--------------|--------------|
| 1x4  | \$104.50          | .27         | .35          | .42          | .49          | .57          | .64          | .71          |
| 1x6  | \$156.75          | .43         | .54          | .65          | .76          | .88          | .99          | 1.10         |
| 1x8  | \$209.00          | .58         | .72          | .87          | 1.01         | 1.17         | 1.31         | 1.46         |
| 1x10 | \$261.25          | .73         | .92          | 1.10         | 1.28         | 1.49         | 1.67         | 1.86         |

#### NO. 2 AND BETTER FIR AND HEMLOCK

| Size | Quantity Per 1000 | 8 Ft. Lgth. | 10 Ft. Lgth. | 12 Ft. Lgth. | 14 Ft. Lgth. | 16 Ft. Lgth. | 18 Ft. Lgth. | 20 Ft. Lgth. |
|------|-------------------|-------------|--------------|--------------|--------------|--------------|--------------|--------------|
| 1x4  | \$108.00          | .29         | .36          | .43          | .50          | .59          | .66          | .73          |
| 1x6  | \$162.00          | .44         | .55          | .66          | .77          | .90          | 1.01         | 1.13         |
| 1x8  | \$216.00          | .58         | .72          | .88          | 1.02         | 1.20         | 1.35         | 1.47         |
| 1x10 | \$270.00          | .72         | .91          | 1.10         | 1.28         | 1.50         | 1.69         | 1.88         |
| 1x12 | \$324.00          | .90         | 1.12         | 1.34         | 1.57         | 1.83         | 2.06         | 2.29         |



### ATTRACTIVE SIDING MAKES BEAUTIFUL HOMES

There are many advantages in buying siding from us. We deal direct with the largest mills in the country. These enormous purchases mean lowest prices to you. Our large building and estimating staff will help you select the proper siding, and figure your needs with no cost or obligation. If the siding you have in mind is not listed below, phone, mail or visit us.

#### (A) Novelty Pattern Drop Siding

Used extensively as a siding for houses, camps, garages, barns, poultry houses and other buildings. Applied directly to studding.

**DELUXE GRADE "C" and "BTR" \$19.80**

FIR 100 Bd. Ft. ....

Standard lengths—when painted makes a fine finish.

**ECONOMY GRADE per 100 Bd. Ft. .... \$ 9.80**

No. 2 Yellow Pine Common. Where economy is desired, this grade will prove satisfactory.

#### (B) Bevel Siding

One of the finest siding units ever developed. Can be effectively used on almost every style of architecture. Beautifully butted. Siding is size 1/2"x6 inches. Lengths vary from 3 feet to 20 feet. Stocked in two grades. Deluxe grade is 100% perfectly clear.

**DELUXE GRADE, 100 Bd. Ft. .... \$19.80**

Utility Grade per 100 Bd. Ft. .... \$12.50

The Utility grade is not clear, having some defects, and is used where a more economical siding is desired, but will give satisfactory service. Size 1/2"x8".



### BEADED CEILING

(A) Clear grade of fir... rich, clear grain, smoothed and beaded one side... correctly tongued and grooved for easy fit. 5/8"x4" in random lengths.

Per 100 Feet. .... \$ 22.00

Same High Quality, per 1000 feet. .... \$220.00



### (A) Roofer or Shiplap Sheathing

Good grade of Yellow Pine No. 2 common. Used for siding or roof base, where an easy to apply, close fitting joint is desired. Size 1x8 inches, random lengths per 100 Bd. Ft.

Same high quality and size

Per 1000 Bd. Ft. .... \$119.00

### (B) Tongued and Grooved Flooring

Yellow Pine No. 2 Common. Used for siding roof boards, partitions, subfloors, sheds and all general purposes, random lengths, size 1x6 in.

Per 1000 Bd. Ft. .... \$119.00

### (C) S4S Square Edge Boards

Yellow Pine No. 2 Common, dressed four sides. Generally used for sheathing, pickets and general purposes, where a tight joint is not essential. Random lengths.

Size 1x4 in. per 1000 Bd. Ft. .... \$98.00

Size 1x6 in. per 1000 Bd. Ft. .... \$98.00

### TRIM BASEBOARDS

When you replace your floors, or if your present baseboards are badly scarred and worn—replace them. You can easily do it yourself, and it costs so little with these Low Prices.

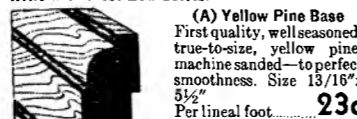

(A) Yellow Pine Base  
First quality, well seasoned, true-to-size, yellow pine, machine sanded—to perfect smoothness. Size 1 3/8" x 5 1/2"  
Per lineal foot. .... \$23c

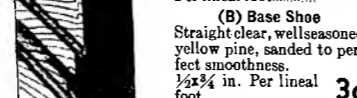

(B) Base Shoe  
Straight clear, well seasoned yellow pine, sanded to perfect smoothness.  
1/2" x 3/4" in. Per lineal foot. .... \$3c

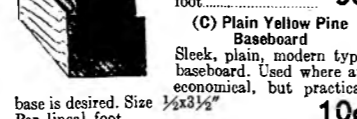

(C) Plain Yellow Pine Baseboard  
Sleek, plain, modern type baseboard. Used where an economical, but practical base is desired. Size 1 3/8" x 3 1/2"  
Per lineal foot. .... \$10c

### RED CEDAR CLOSET LINING

Easily installed on old or new closets. Velvet smooth surface, end matched. Tongues and Grooves are cut for a close, smooth fit. Gives you absolute protection against moths and insects. Cedar lining is 3/8 in. thick, 2 1/2 in. wide.  
Per 40 Bd. Ft. .... \$8.50



**Home Improvements, Your Best Investment**  
In times like this, you couldn't put your money to better use than improving your home. It's a safe, permanent investment... for as markets rise, your investment grows more valuable. Study this catalog now and determine your needed home improvements.

### INSIDE AND OUTSIDE MOULDING NEEDS

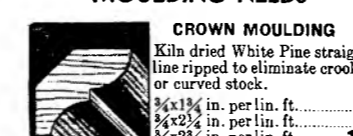

#### CROWN MOULDING

Kiln dried White Pine straight-line ripped to eliminate crooked or curved stock.

3/4" x 1 1/2" in. per lin. ft. .... 5c

3/4" x 2 1/2" in. per lin. ft. .... 7c

3/4" x 3 1/2" in. per lin. ft. .... 10c

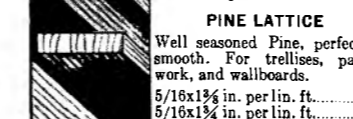

#### PINE LATTICE

Well seasoned Pine, perfectly smooth. For trellises, panel work, and wallboards.

5/16 x 1 3/8 in. per lin. ft. .... 3c

5/16 x 1 1/4 in. per lin. ft. .... 3c

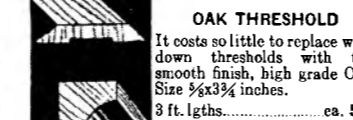

#### OAK THRESHOLD

It costs so little to replace worn down thresholds with this smooth finish, high grade Oak. Size 3/8" x 3 3/4" inches.  
3 ft. lgths. .... ea. 55c

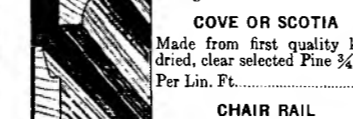

#### COVE OR SCOTIA

Made from first quality kiln dried, clear selected Pine 3/4 in.

Per Lin. Ft. .... 3c

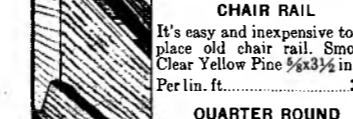

#### CHAIR RAIL

It's easy and inexpensive to replace old chair rail. Smooth Clear Yellow Pine 5/8" x 3 1/2" in.

Per lin. ft. .... 10c

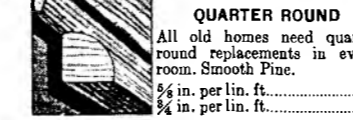

#### QUARTER ROUND

All old homes need quarter round replacements in every room. Smooth Pine.

3/4 in. per lin. ft. .... 3c

1/2 in. per lin. ft. .... 3c



**LET US HELP YOU PLAN YOUR JOB!**

Don't let your home become run down and suffer in value as well as in appearance. Our remodeling experts will assist you in planning the improvements necessary to transform your home into a new one, attractive in appearance and with all the conveniences of a newly built home.

**You Don't Need Cash—Use Our Convenient Easy Payment Plan . . . . Spread Your Payments Over Many Months.**

Whether you buy a stick or a carload you'll find our service quick and efficient—giving you lumber "CUT-TO-SIZE." Beside the lumber you can depend on "Thrift" to furnish you with any material for your building. Starting at the basement and ending on the roof. Just visit us and see for yourself.

### FREE PLANNING—FREE ESTIMATES

For just a few dollars, you can transform the interior of your home with new hardwood floors, add an additional room, or many other improvements. Mail, phone or visit our yards, for Free Estimates, Free Planning, and further information about our Easy, Convenient Payment Plan.

## ADD EXTRA ROOMS WITH WALLBOARD

—You can make waste space into livable space! . . . at a very little cost, too! . . . INVESTIGATE!



### MASONITE

These very desirable boards are colored in the making... Saws or cuts with a knife. No dirt—no waste—no delay. Panels are nearly 1/2" thick—thoroughly dried and seasoned—can be nailed directly to rafters or studs—makes a beautiful, permanent, sanitary wall or ceiling.

| Size   | Price Each | Size   | Price Each |
|--------|------------|--------|------------|
| Sheet  | \$1.18     | Sheet  | \$1.55     |
| 4'x4'  | 2.35       | 4'x4'  | 3.10       |
| 4'x8'  | 3.54       | 4'x8'  | 4.65       |
| 4'x12' |            | 4'x12' |            |

### DOUGLAS FIR PLYWOOD

Made of 3 pieces of Veneer—the inner Veneer laid cross grain—compressed under heavy hydraulic pressure in water-proof glue. Four times as strong as solid lumber—Won't twist, warp or split. Beautiful rotary cut figured grain of the wood presents a very handsome appearance. Easy to apply with only a hammer and a saw. Ends are square cut, ready for use. Sound one side, net thickness 3/4"

| SIZE | PRICE PER PANEL |
|------|-----------------|
| 4x6  | \$4.95          |
| 4x7  | 5.88            |
| 4x8  | 6.69            |
| 4x9  | 7.49            |
| 4x10 | 8.39            |

#### Uses of Plywoods:

Paneling rooms, adding rooms, display racks, table tops, partitions, magazine stands, lining cabinets, display signs, lining garage, making drawers, etc.

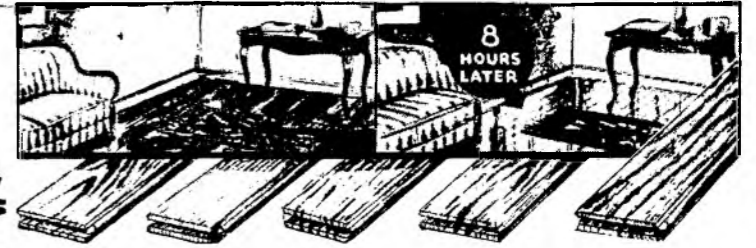

### HARDWOOD FLOORS ARE NOT EXPENSIVE BUT ADD VALUE TO ANY HOME!

Enjoy the luxury and endurance of genuine Hardwood Floors which are easier to clean and keep clean, and much more beautiful. Buyers and renters of property are always willing to pay more when the home has hardwood floors. Let us show you how easy and inexpensive new floors can be laid in your home. We will be glad to furnish a free estimate covering the materials for the entire job.

### OAK FLOORING with Beautiful Grain.

DELUXE GRADE, has a beautiful grain that distinguishes it from all other floors. Flooring Tongued and Grooved. Size 2 1/2"x3 1/4". Side & End Matched.

Per 100 bd. ft. .... \$22.50

### FLOORING FOR GENERAL OUTSIDE USE.

KILN DRIED 1"x4" FIR FLOORING, Chiefly used for porches or interiors where excessive moisture is prevalent. Clear and free from knots, with a long even grain, to assure longer wear. Tongued and grooved.

Per 100 sq. ft. .... \$24.95

1"x4" FLAT GRAIN FIR FLOORING Contains both mixed rift and flat grain, but is average grade, true-to-size and well seasoned. Sold for use where higher grade flooring is not warranted. Tongued and Grooved.

Per 100 sq. ft. .... \$14.95



### IT'S EASY TO LAY FLOORING

Hardwood flooring can be laid over old floors without special preparation. On new work, an inexpensive sub-floor should be laid first. Lay flooring at right angles to the old floor and blind nail with flooring nails placed about 8 inches apart.

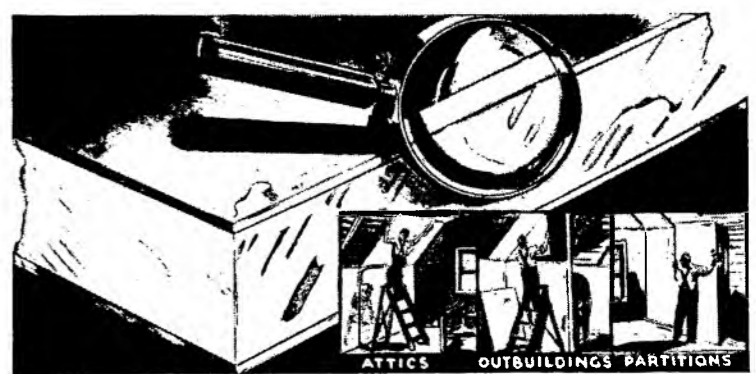

### DURABLE WALL PLASTERBOARD EXCELLENT SUBSTITUTE FOR LATH AND PLASTER—STRONG, HEAVY.

This Plaster Board is made by rolling a hard setting plaster and allowing it to dry into hard sheets. Sanitary, moisture proof and unaffected by extreme temperatures. When the wall is to be painted or calcimined without the use of panel strips, a perfectly smooth wall can be obtained by using a small amount of Patching Plaster. Easily nailed to wood studding, furring or joists. Comes in large sheets, 3/8" thick.

|                          |        |
|--------------------------|--------|
| Size 4x6 ft. Sheet. .... | \$1.32 |
| Size 4x8 ft. Sheet. .... | 1.76   |
| Size 4x7 ft. Sheet. .... | 1.54   |
| Size 4x9 ft. Sheet. .... | 1.98   |



### Insulating Wallboard

Five times the insulating value of plaster board or rock lath. Use it for permanent walls, to sound-proof partitions, to re-decorate or reclaim attics and basements. Can be sized painted, calcimined or plastered over. Made from long, tough fibers, tightly compressed into rugged board.

| SIZE                | PRICE PER SHEET |
|---------------------|-----------------|
| 4x6 ft. Sheet. .... | \$1.49          |
| 4x7 ft. Sheet. .... | 1.68            |
| 4x8 ft. Sheet. .... | 1.92            |

### PICKET FENCE SECTION

Each 8 foot section contains 17 pickets (1"x3") . . . 2 horizontal pieces (1"x3"x8") . . . 1 post (2"x3"x6") . . . all surfaced on 4 sides.

|                          |        |
|--------------------------|--------|
| 24 Inches High . . . . . | \$2.98 |
| 32 Inches High . . . . . | \$3.69 |
| 36 Inches High . . . . . | \$3.89 |

**BUY NOW—PAY LATER ON F.H.A.**

**REMEMBER! REPAIRS COST SO LITTLE BUT ADD DOLLARS OF VALUE TO YOUR HOME! AND YOUR CREDIT IS GOOD AT THRIFT!**

# REPAIR YOUR LEAKY ROOFS OR GUTTERS QUICKLY AND ECONOMICALLY...HERE'S HOW!

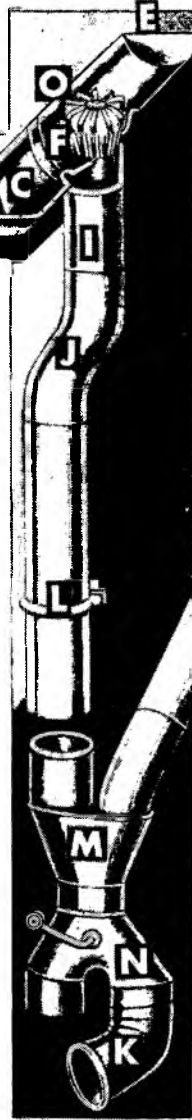
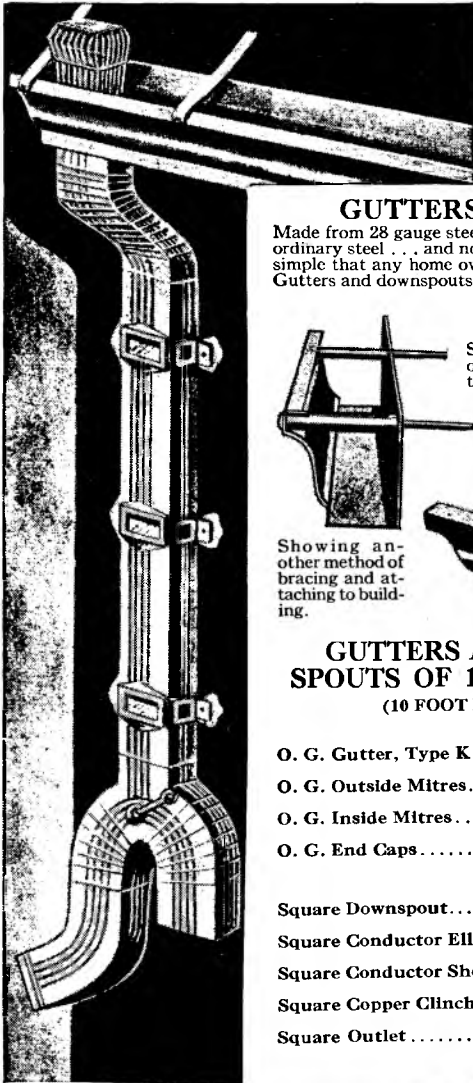

## GUTTERS AND DOWNSPOUTS OF COPPER BEARING STEEL

Made from 28 gauge steel containing copper and heavily galvanized . . . a very economical material that will last longer than ordinary steel . . . and no solder is needed with our modern method of **SOLDERLESS SLIP JOINTS**. In fact installation is so simple that any home owner can replace gutters or down spouts at a cost of \$5.00 to \$15.00 saving expensive labor charges. Gutters and downspouts are sold in 10 foot lengths and are easily cut to fit on the job with hacksaw or snips.

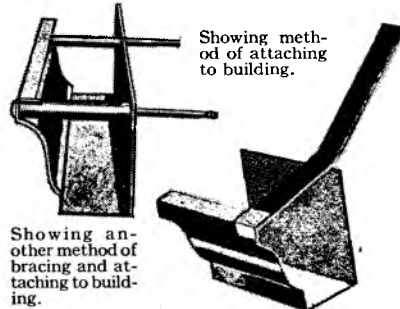

Showing method of attaching to building.

Showing another method of bracing and attaching to building.

## GUTTERS AND DOWNSPOUTS OF 16 oz. COPPER (10 FOOT LENGTHS)

|  | 5"         |
|--|------------|
| O. G. Gutter, Type K . . . . .         | \$6.98 lg. |
| O. G. Outside Mitres . . . . .         | 1.98       |
| O. G. Inside Mitres . . . . .          | 1.98       |
| O. G. End Caps . . . . .               | .79        |
|  | 3"         |
| Square Downspout . . . . .             | \$5.89 lg. |
| Square Conductor Ell . . . . .         | 1.19       |
| Square Conductor Shoe . . . . .        | 1.39       |
| Square Copper Clincher Bands . . . . . | .29        |
| Square Outlet . . . . .                | .55        |

|  | 2"     | 3"     | 4"     | 5"     | 6"     |
|--|--------|--------|--------|--------|--------|
| A. Gutters or Eave Trough—10' lengths—28 Ga. . . . . |        |        | \$ .98 | \$1.10 | \$1.25 |
| Gutters—26 Ga.—10' length . . . . .                  |        |        |        | 1.29   |        |
| B. Slip Joint Coupling . . . . .                     |        |        | .19    | .23    | .25    |
| C. Outside Corner or Mitre . . . . .                 |        |        | .70    | .79    | .98    |
| D. Inside Corner or Mitre . . . . .                  |        |        | .70    | .79    | .98    |
| E. Gutter End Cap . . . . .                          |        |        | .23    | .25    | .33    |
| F. SEE PRICES BELOW . . . . .                        |        |        |        |        |        |
| G. Gutter Wire Hangers . . . . .                     |        |        | .05    | .06    | .07    |
| H. Gutter Strap Hangers . . . . .                    |        |        | .14    | .16    | .19    |
| I. Rainspout or Conductor . . . . .                  | \$ .95 | \$1.05 | 1.35   |        |        |
| J. Conductor Elbows . . . . .                        | .29    | .35    | .59    |        |        |
| K. Conductor Shoe . . . . .                          | .47    | .62    | .89    |        |        |
| L. Conductor Hook . . . . .                          | .11    | .17    | .25    |        |        |
| M. Conductor Funnel . . . . .                        | .45    | .62    | .89    |        |        |
| N. Conductor Cutoff . . . . .                        | 1.05   | 1.10   | 1.49   |        |        |
| O. Strainers . . . . .                               | .15    | .25    | .29    |        |        |
|  | 4x2    | 5x3    | 5x4    |        |        |
| F. Gutter Outlet . . . . .                           | .49    | .59    | .69    |        |        |

## GALVANIZED

|   | 2x3    | 3x4    | 4      | 5      | 6      |
|---|--------|--------|--------|--------|--------|
| O. G. Gutter, Type K . . . . .            |        |        | \$1.20 | \$1.30 | \$1.45 |
| O. G. Outside Mitres . . . . .            |        |        | .79    | .90    | .98    |
| O. G. Inside Mitres . . . . .             |        |        | .79    | .90    | .98    |
| O. G. End Caps . . . . .                  |        |        | .55    | .65    | .75    |
| Gutter Spike . . . . .                    |        |        | .05    | .05    | .05    |
| Gutter Ferrules . . . . .                 |        |        | .06    | .06    | .06    |
| Square Downspout . . . . .                | \$1.15 | \$1.29 |        |        |        |
| Square Conductor Ell . . . . .            | .39    | .49    |        |        |        |
| Square Conductor Shoe . . . . .           | .20    | .25    |        |        |        |
| Square Conductor Hooks . . . . .          |        |        |        |        |        |
| Square Conductor Clincher Bands . . . . . | .11    | .15    |        |        |        |
|   |        |        |        |        |        |
| Square Conductor Cutoff . . . . .         | 2.19   | 2.72   |        |        |        |
| Square Conductor Strainers . . . . .      | .39    | .65    |        |        |        |
| O. G. Outlet . . . . .                    | .15    | .19    |        |        |        |

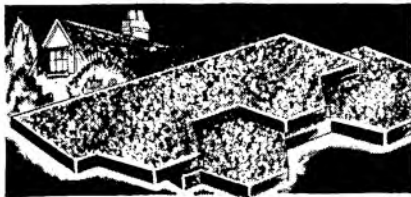

## HEXAGON SHINGLES

Coated both sides with pure asphalt and surfaced with a thick layer of real slate chips. Finished in fade-resisting roofing colors, these shingles will give satisfactory service for 15 to 20 years. They will not dry and crack, nor will they curl. Uniformly correct in thickness and weight. Self spacing. Standard weight, 167 lbs. per square (100 sq. ft.) coverage 11 1/4" x 36" - 2" headlap. Laid 4" to **\$2.43** weather. Choice of colors, per bundle . . .

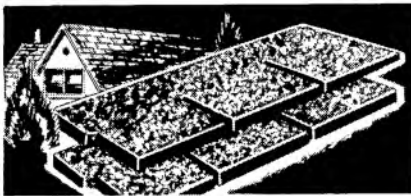

## 3-IN-1 BUTT SHINGLES

The "Jumbo" weight of these shingles is an over-all thickness, not just thick at the exposed edges. Thicker and heavier felt is used, than in ordinary shingles. Thoroughly saturated with pure asphalt and surfaced with brilliantly colored real slate chips. Fade-proof colors. Meets U. S. Government specifications. Self-spacing. Three bundles cover 100 sq. ft. . . . actually weigh 210 pounds to the square (3 bundles to the square). Laid 4" to **\$2.15** weather. Choice of colors, per bundle . . .

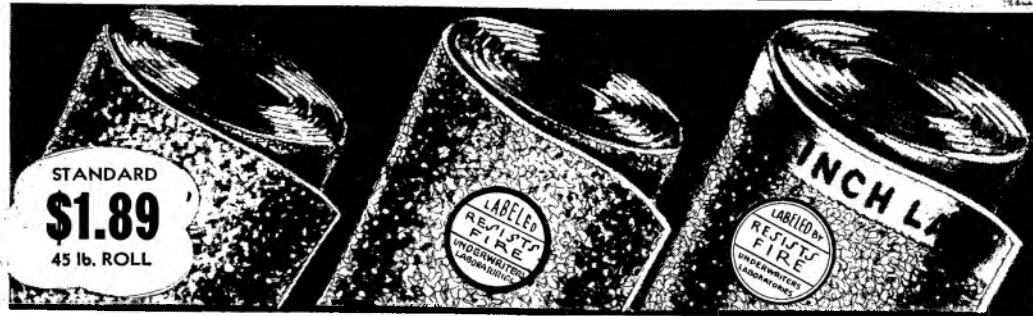

## ASPHALT ROOFING

This is a heavy felt, saturated and coated on both sides with a good grade of asphalt and surfaced on both sides with talc. This low-cost roofing is sold for use where higher grade roofing is not warranted. Although it is not equal to our "BEST QUALITY" roofing, it will give you many years of highly satisfactory service. Included in our low price are the necessary nails and lap cement. **\$1.89** Standard 45 lbs. per roll . . .

## BEST QUALITY ASPHALT ROOFING

Here is a really peak quality roofing. Expertly made from full weights of heavy, long-fibre felt, thoroughly saturated with selected asphalt. Mica-surfaced on both sides, resists fire, repels heat . . . an effective weather armor. At our low prices, you can well afford the protection. Each 36" wide roll (108 sq. feet) includes nails and lap cement. **\$2.39** Heavy, 55 lbs. per roll . . . **\$2.72** Extra Heavy, 65 lbs. per roll . . .

## MINERAL SURFACE ROOFING

Add color and distinction to your roof with this high-grade, fire-resisting roofing. Suitable for homes, barns and other buildings where protection and appearance are prime factors. Saturating long fibre, top-grade felt quality. Surfaced firmly with mineral chips, it resists fire and any weather. Each roll covers 100 sq. ft. with 2" lap. Choice of red, green, blue black . . . including nails and lap cement. **\$2.98** 90 lb. roll . . . . .



## BRICK ROLL SIDING

Will give your home the appearance of solid brick . . . easily installed . . . acts as insulation . . . roll contains 100 square feet . . . **\$3.55** per roll . . . . .

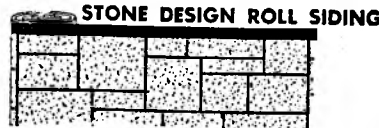

## STONE DESIGN ROLL SIDING

As easy put on as any common siding . . . and it gives your home the solid appearance of solid stone . . . very easily installed . . . **\$3.55** per roll of 100 feet at . . . . .

## 15 LB. ASPHALT FELT

This is a very good felt . . . thoroughly saturated with asphalt . . . ideal for lining out-buildings and for use under asbestos or wood siding or floors . . . roll covers 400 square feet . . . per roll **\$3.98**

# NOW . . . A WATER SOFTENER THAT CAN'T RUST

## The Kleen-Stone is Guaranteed Rust Proof for Twenty Years

### Double Quick STREAMLINE HEATER

- ★Fully Insulated
- ★Saves Gas

**\$15<sup>95</sup>**

Here's a new heater that's truly modern both in appearance and operation. Handsomestreamlining plus its glistening baked enamel finish make it simple to clean. Complete insulation prevents heat loss and cuts down your gas bill. Seamless double copper coils assure quick delivery of hot water. Flashlighter equipped, it lights safely and without opening door. Easily installed . . . can be attached to any boiler without changing present pipe lines. Approved by American Gas Association.

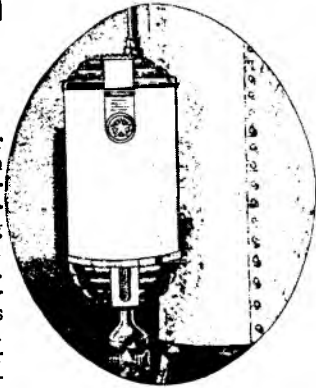

Double Quick Streamline Heater. **\$15.95** Extra Capacity Double Quick Heater **\$17.90**

### KLEEN • STONE Water Softener

This ideal partner to our famous Kleen-Stone water heater will supply you with sparkling clear soft water for drinking, cooking, and every household use. The same sanitary stone lining has been applied to this softener, bringing you absolute rust proof protection, backed by a 20-year written guarantee.

**\$89<sup>00</sup>**

35,000 GRAIN CAPACITY

There is nothing complicated about our softener. You can install it yourself in just a few hours. When you buy your own water softener . . . it's yours for keeps. There's no monthly service charge to pay . . . no strangers tracking through the house to recharge the tank. Once installed, it requires very little attention.

### We'll Help You Select the Proper Boiler and Heater

Dozens of combinations can be made from the many boilers, heaters, and accessories on these pages. If you are not sure about the correct boiler, heater, or fittings to complete an assembly for your home, just ask our men. They're experienced plumbing men, and they're glad to help you.

### STANDARD GALVANIZED BOILERS

| Gals. | Inches |         |
|-------|--------|---------|
| 30    | 12x60  | \$12.95 |
| 40    | 14x60  | 17.55   |
| 15    | 12x30  | 14.50   |

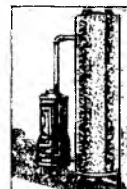

Made of full gauge copper-bearing steel, heavily galvanized inside and out. Electrically welded. Tested under pressure at the factory. *Extra heavy weight.* 150-lbs. per sq. in. working pressure.

### REPAIR PARTS FOR EVERY TYPE OF BOILER OR HEATER

We have a complete selection of first quality fittings and accessories for all boilers and heaters. Come in. See our displays. Prices are low—plainly marked.

- (A) Boiler Stand  
Tripod type. Adjustable. . . . . **65c**
- (B) Brass Drain Cock  
1/2" Pipe Thread. Outlet has standard hose thread. . . . . **.89c**
- (C) Copper Circulator  
Connects heater to boiler without threading pipe. Unions included. . . . . **\$2.49**
- (D) Dip Tube  
Promotes fast circulation; gives quick hot water. 1/2" size. . . **.95c**
- (E) Boiler Unions  
Solid brass with ground seats.  
Straight top cplg. **90c**  
Bent top cplg. . . **95c**  
Boiler and heater union. . . . . **90c**
- (F) Boiler Ell  
Long sweep pattern. Galvanized. . . . **50c**  
Brass. . . . . **65c**
- (G) Boiler Plug  
Plugs leak in boiler. Easily put in place. . . . . **.15c**
- (H) Heater Valve  
Brass. Straight or angle pattern. . . **85c**



### COAL-FIRED WATER HEATERS

These coal heaters are made of the best grey iron and tested for high water pressure. Deep ash pits. Easily operated grates. Require firing only twice daily. Sizes for every requirement.

Dome-type heater, can be used with any size tank from 30-gallon to 85-gallon. **\$16.95**  
Combination Water Heater and Laundry Stove . . . . . **\$15.90**



### HEATERS! EVERY TYPE AND SIZE

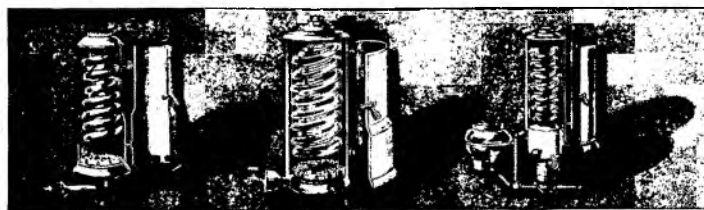

- |   |   |   |
|---|---|---|
| <p><b>DOUBLE COIL GAS HEATER</b><br/>Efficient 3/4" copper coils. Star drilled burner and cast jacket. Will replace single or double coil heater. Includes gas valve. <b>\$15.95</b><br/>Similar heater with cast iron coil. . . . . <b>\$12.95</b></p> | <p><b>JUMBO GAS WATER HEATER</b><br/>For use where large amounts of hot water are needed. Heavy duty 3/4" copper coils. A. G. A. approved. Complete with gas valve. Double coil. . . . . <b>\$21.00</b><br/>Triple coil. . . . . <b>49.95</b></p> | <p><b>KEROSENE WATER HEATER</b><br/>For homes without gas supply. Giant burner gives a blue, hot, noiseless flame. Newly designed for extra fuel economy. No fumes or smoke. Complete. . . . . <b>\$38.95</b></p> |
|---|---|---|

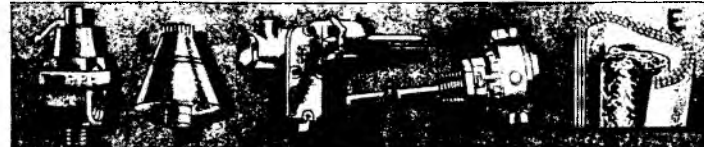

### These Gas Savers Quickly Pay for Themselves

- (A) Pressure Relief Valve. An insurance you can't afford to be without. Gives positive protection against boiler explosions. Easily inserted in pipe line above boiler. Made of bronze. . . . . **\$2.69**
- (B) Draft Hood. Prevents back-draft from blowing out flame in heater. Also keeps excessive up-draft from sucking up heat . . . cuts your gas bill. Fits any water heater. **95c**
- (C) Snap Action Thermostat with Pilot. Makes any heater automatic. Saves steps . . . no need to light or turn down heater. Water temperature stays at thermostat setting. Saves gas . . . boiler is never overheated. Has no moving parts to get out of order. A.G.A. approved. . . . . **\$8.35**
- (D) Throttle Type Automatic Thermostat. Similar to above—lower priced. Without pilot. . . . . **\$6.90**
- (E) Air-Cell Boiler Jacket. Keeps all the heat in the water. Cuts gas bills. Anyone can attach it to tank in 20 minutes. 30-gal. . . . . **\$3.95** 40-gal. . . . . **\$5.45**

**NEW!**

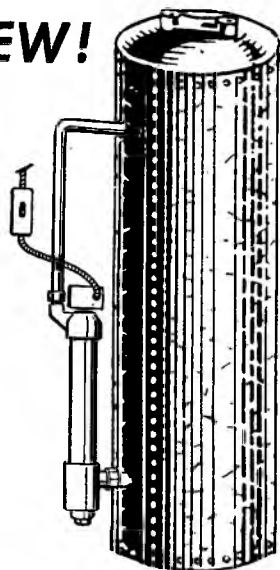

### A NEW SIDEARM AUTOMATIC ELECTRIC HEATER **\$37<sup>95</sup>**

Simple! Efficient! Economical!  
Underwriters Lab. Approved!

Will convert your present tank into a fully automatic unit . . . operates on 115 volts A.C. and comes complete with brass unions and copper circulation coil . . . nothing else needed—just hook it up!

### Instantaneous Water Heater

Supplies hot water as long as faucet remains open.  
2 1/2-gal. per min. . . . . **\$149.50**  
3-gal. per min. . . . . **199.50**  
4-gal. per min. . . . . **265.00**

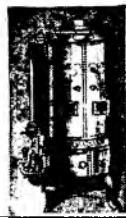

# HOW DO THESE PRICES COMPARE WITH PRICES TWO YEARS AGO?

Yes, some of the prices on this page are slightly higher than prices 2 years ago, when O.P.A. was still in existence. To be exact, 46 of them have gone up. (The other 56 are still the same or even lower.) On those that have advanced, the increase averages less than 8%—the exact amount of the manufacturer's increase. Compare that with the way other items in the family budget have sky-rocketed.

## Sink Faucets

A full weight cast brass faucet of pleasing appearance. Will fit any sink Adjustable flange. Chrome plated.  
Lever Handle.....\$1.98  
Cross Handle.....\$2.45

## Plain Bibbs

A good grade, plain faucet at a very low price.  
1/2" rgh. brass.....\$0.89  
1/2" pol. brass.....1.19  
3/4" rgh. brass......98

## Hose Bibbs

Standard grade. Spout end fits any hose.  
1/2" rgh. brass.....\$1.09  
1/2" pol. brass.....1.49  
3/4" rgh. brass.....1.19

## S.O.T. Bibb

Old style solder or thread faucet with long shank and 3/8" pipe thread. Heavy brass.  
Plain.....\$1.62  
Hose.....1.32

## Laundry Bibb

Stub pattern faucet used on laundry trays.  
Plain.....\$1.50  
Hose.....1.60

## Sill Cock

An outside faucet for lawn sprinkling. Hose spout set at a convenient angle to avoid kinking hose. Wheel handle removable.  
1/2" brass.....\$1.19  
3/4" brass.....1.29

## Drain Cock

For draining boiler, etc. A good grade that will give satisfaction, yet priced extremely low.79c

## Stop Valve

For use on supply pipes of closets, lavatories and bath tubs. Cast brass, well finished.  
3/8" chrome plated..\$1.90  
1/2" chrome plated..1.90

## Stop Valve

Angle pattern. For wall supply pipe of closet, lavatory and bathtub. Cast brass, well finished.  
3/8" chrome pltd...\$1.90  
1/2" chrome pltd....1.90

## Self-Closing Valve

Shuts off automatically when hand is removed from handle. Used in public places to avoid waste of water. Expert construction, efficient in service. Cast brass, chrome plated....\$3.60

## Stop and Waste Valve

Standard grade at low price. When waste outlet is closed, it operates as plain stop valve. Should be used on all water lines. Size 1/2" pipe thread..89c

## Improved Stop and Waste Valve

Best quality of cast bronze, precisely machined. Built for long, satisfactory service. By closing waste, operates as regular stop valve.  
1/2".....\$1.28  
3/4".....\$1.39  
1".....\$2.69

## Stop and Waste Valve

Heavy cast brass valve, removable lever handle.  
1/2" size.....\$1.39

## Curb Cock

A high quality stop valve used for service line at curb. Tee handle.  
3/4".....\$3.15  
1".....\$4.98

## IMPROVE YOUR SINK WITH A SET OF THESE GLEAMING CHROME FAUCETS

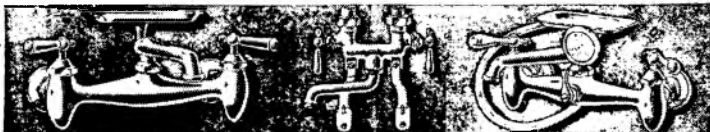

### Swing Spout Faucet

A popular sink faucet. Heavy construction. Attractive design. Solid bronze Jewelry chrome finish. Removable soap dish.  
Fits any sink.....\$7.95

### The Laundry Faucet

Ideal combination faucet. Swinging spout threaded for hose. Solid brass. Rough nickel finish. Including clamps and union  
for 1/2" pipe. Only \$3.95

### The Spray Faucet

A convenient sink fixture. Water is changed from spout to hose by raising diverter. Solid bronze. Jewelry chrome plated.  
Fits any sink.....\$15.95



### The Leader Bath Faucet

Smart in appearance. Exceptionally heavy. Handles indexed hot and cold. Spout shaped to fit any shampoo spray. Cast brass, chrome finish.....\$6.90

### Double Duty Bath Faucet

Streamlined faucet with removable soap dish placed just where you want it. Spout takes regular shampoo spray. Cast bronze, finished in jewelry chrome.....\$7.95

### The Thriftee Bath Faucet

Fits all bathtubs. Spout suitable for shampoo connections. Handles indexed hot and cold. Solid Brass, chrome plated. A remarkable value at.....\$3.49



### (A) The Cottage Basin Faucet

Compact for small lavatories. Brass, chrome plated. Handle indexed hot or cold. Also in cross handle pattern. Coupling nut and tailpiece included.....\$1.98

### (B) The Quality Basin Faucet

Exceptional high grade. Cast bronze. Jewelry chrome finish. Hot or cold. Lever handle if desired. Including coupling nut and tailpiece.....\$2.45

### (C) The Futura Basin Faucet

Latest design. Highest quality. Jewelry chrome finish. Hot or cold. Also with lever handle. Including coupling nut and tailpiece.....\$3.40

### (D) Self-Closing Basin Faucet

Shuts off automatically. Saves water. Intended for public wash rooms. Best construction. Chrome finish. Including coupling nut and tailpiece.....\$3.80

Space permits showing only a few of our large variety of faucets and valves. Visit our store; inspect complete display. We have everything in plumbing.



These valves are of cast bronze, carefully machined and exactly suited to their particular purpose. Visit our store to make satisfactory selection.

|                            |       |       |        |        |        |        |        |        |
|----------------------------|-------|-------|--------|--------|--------|--------|--------|--------|
| (A) Globe Valve.....       | 1/4"  | 3/8"  | 1/2"   | 3/4"   | 1"     | 1 1/4" | 1 1/2" | 2"     |
| (B) Angle Valve.....       | \$.95 | \$.98 | \$1.25 | \$1.62 | \$2.23 | \$2.61 | \$3.68 | \$5.43 |
| (C) Gate Valve.....        | .98   | 1.25  | 1.43   | 1.45   | 1.67   | 1.95   | 2.33   | 2.82   |
| (D) Horizontal Check Valve | .98   | 1.05  | 1.31   | 1.64   | 2.13   | 2.43   | 3.21   | 4.38   |
| (D) Swing Check Valve..... |       |       | 2.30   | 2.68   | 3.14   | 3.23   | 3.80   |        |

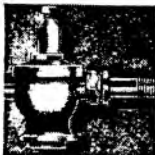

## WATER PRESSURE REGULATOR

Reduces water pressure to desired point. Easily installed. Saves water faucets and valves.

1/2".....\$8.95      3/4".....\$10.95



## SUPPLY PIPES

### For Bathrooms

1/2" Offset, chrome plated.....\$2.65

For Lavatories—Straight or Angle

3/8" chrome plated, ea.....\$2.65

3/8" chr. pltd. with stop valves, ea. 3.95

### For Closets

Full length, each......98c

## FAUCET REPAIRS

### Washers

We carry an immense variety of washers and repairs—if it's for plumbing you will find the needed item at our store.

### China Handle (Cross)

Will fit most any faucet. Easily attached with our spud cement. Indexed hot or cold.....30c

### China Handle (Lever)

Easily attached to most any faucet with our spud cement. Indexed hot or cold.....15c

### Spud Cement

Attaches china handles to metal spuds permanently and easily.....10c

### Chrome Handle (Cross)

For replacing any type of old handle. Steel core cuts its own thread on faucet stem.....59c

### Chrome Handle (Lever)

Replaces old handle easily and without special tools. Hot or cold.....30c

### China Soap Dish

Attach with our Spud cement to old metal spud.....55c

### Chrome Soap Dish

Replaces old china or metal soap dish. With spud.....98c

### Repair Stem

Replaces wornout faucet stem. Attach quickly with wrench and screwdriver.....59c

For swing spout faucets. With handle.....69c

### Faucet Nozzle

Fits most bath faucets and shampoo connections. Quickly installed.....35c

### Basin Coupling Nuts and Tails

For lavatory faucets. Bring old piece with you for matching.  
Coupling Nut.....15c  
Tailpiece.....15c

### Bath Couplings

For connecting bath supply pipes to faucet. Ground joint serves as union. Complete.....49c

### Bath Coupling

Offset pattern. Connects bathtub supply pipe to faucet.....79c

## HOSE FITTINGS

### Hose Nozzle

Fits all hose couplings.....48c

### Hose Coupling

1/2" 25c      3/4" 25c      1" 25c

### Hose Coupling

Perfect clinching, requires no clamp.  
1/2" 30c      3/4" 30c      1" 30c

### Hose Mender

Perfect clinching, requires no clamp.  
1/2" 12c      3/4" 12c      1" 12c

### Hose Clamp

1/2" 4c      3/4" 4c      1" 4c

### Hose Adapter

Adapts hose thread to 1/2" pipe thread.....29c

### Water Thief

Provides hose thread for plain spout faucet....57c

## EVERYTHING YOU NEED IN HEATING SUPPLIES . . . . .

- HOT WATER BOILERS
- HOT AIR FURNACES
- COAL STOKERS
- OIL BURNERS
- REPAIRS OF ALL KINDS!

WE CAN SUPPLY FITTINGS FOR ANY PLUMBING FIXTURE IN YOUR HOME

# PRICES? MANY ARE ACTUALLY LOWER THAN O.P.A. CEILINGS

When O.P.A. ended, we didn't let prices go hogwild. If anything, we even lowered them. For instance, check this page. On it there are exactly 110 items priced. This is how they compare with the old O.P.A. prices:  
 25 items are higher than the O.P.A. price  
 34 items are still the same as the O.P.A. price  
 51 items are even less than the O.P.A. price

## PLUMBING REPAIRS

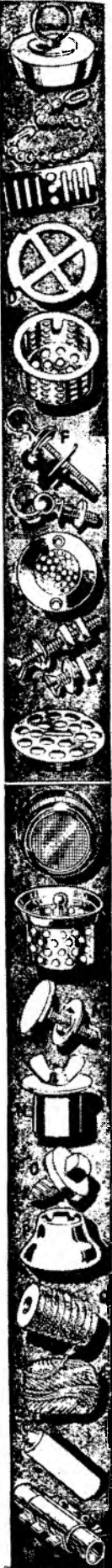

- (A) **Rubber Stoppers**  
High grade rubber, ring securely locked.  
1" ..... 5c  
1 1/2" ..... 5c  
1 3/4" ..... 5c  
1 1/2" ..... 10c  
1 3/4" ..... 10c
- (B) **Stopper Chains**  
New beaded pattern, brass, chrome plated.  
For lavatory ..... 10c  
For bathtub ..... 15c
- (C) **Basin Grating**  
For replacements on old style lavatories.  
Brass, nickel plated. .... 25c
- (D) **Strainer Plate**  
Fits lavatory strainer. Brass, nickel plated  
Easily inserted. .... 10c
- (E) **Hair Cup**  
Insert in lavatory strainer. Catches hair.  
Brass, chrome pltd. .... 10c
- (F) **Chain Stay and Cover**  
Covers opening in lavatory, stay for stopper chain. Brass, chrome plated. .... 35c
- (G) **Chain Stay**  
For lavatory stopper chain. Brass, chrome plated ..... 15c
- (H) **Sink Strainer**  
Large strainer plate. Fits old style flat-rim sinks. Brass, nickel plated. .... 40c
- (I) **Sink Bolts**  
Supports trap collar on old style flat-rim sinks. Brass, nickel plated.  
Short ..... 6c  
Long ..... 8c
- (J) **Strainer Plate**  
Fits regular duplex sink strainer. Brass, nickel plated. Easily inserted. .... 15c
- (K) **Faucet Strainer**  
For swing spout faucet. Strainer screen ..... 5c  
Screen cap ..... 9c
- (L) **Crumb Cup**  
Insert in sink strainer. Catches waste matter. Brass, chrome plated. .... 15c
- (M) **Cock Hole Cover**  
For unused openings in sinks, lavatories or laundry tubs. Brass, chrome plated. .... 30c
- (N) **Trap Plug**  
For cleanout plug on bottom of trap. All sizes. .... 25c
- (O) **Boiler Plug**  
Plugs leaks in hot water boilers quickly and efficiently. .... 15c
- (P) **Escutcheons**  
Complete stock. Chrome-plated brass for all sizes of pipes. As low as ..... 15c
- (Q) **Graphite Packing**  
Graphited asbestos wick for packing all types of valves and faucets. Spool. .... 35c  
Package ..... 10c
- (R) **Candle Wick**  
Finely combed cotton wicking for packing faucets and valves. Ball. .... 15c
- (S) **Plumbers' Candles**  
Each ..... 6c
- (T) **Pipe Clamp**  
Repairs pipe leaks instantly with use of only a screwdriver. Complete with gasket.  
1/2" ..... 28c    3/4" ..... 39c

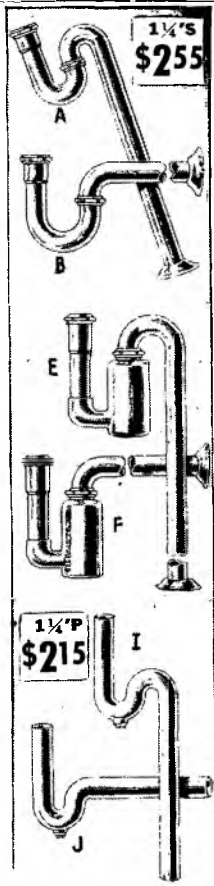

## TRAPS

**BRASS, CHROME PLATED**  
Complete with nuts and washers

- (A) "S" Traps  
1 1/2" satin chrome ..... \$2.55  
1 1/2" polished chrome ..... 2.98  
1 1/2" satin chrome ..... 3.37  
1 1/2" polished chrome ..... 3.75
- (B) "P" Traps  
1 1/2" satin chrome ..... \$1.76  
1 1/2" polished chrome ..... 2.12  
1 1/2" satin chrome ..... 1.95  
1 1/2" polished chrome ..... 2.37
- (C) "P" Traps  
1 1/2" cast brass ..... \$1.95
- (D) Swivel "P" Traps  
1 1/2" x 1 1/2" cast brass ..... \$2.30
- (E) Anti-Siphon "S" Traps  
1 1/2" polished chrome ..... \$8.50  
1 1/2" polished chrome ..... 8.95
- (F) Anti-Siphon "P" Traps  
1 1/2" polished chrome ..... \$7.32  
1 1/2" polished chrome ..... 7.95
- (G) Vented "S" Traps  
1 1/2" polished chrome ..... \$5.46  
1 1/2" polished chrome ..... 6.10
- (H) Vented "P" Traps  
1 1/2" polished chrome ..... \$5.14  
1 1/2" polished chrome ..... 5.76
- LEAD TRAPS**  
(I) "S" Traps  
1 1/2" long ..... \$2.65  
1 1/2" long ..... 3.85
- (J) "P" Traps  
1 1/2" long ..... \$2.15  
1 1/2" long ..... 2.90
- (K) Vented "S" Traps  
1 1/2" long ..... \$4.90  
1 1/2" long ..... 6.55
- (L) Vented "P" Traps  
1 1/2" long ..... \$5.60

Save time and trouble by making our stores your base for all plumbing repairs. We stock everything needed and we will be glad to show you how to make your repairs most economically.

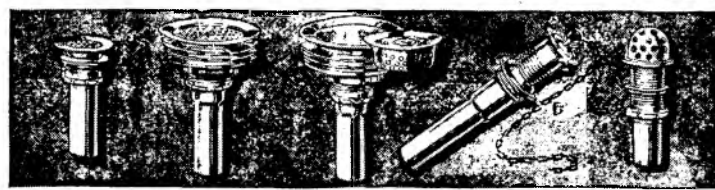
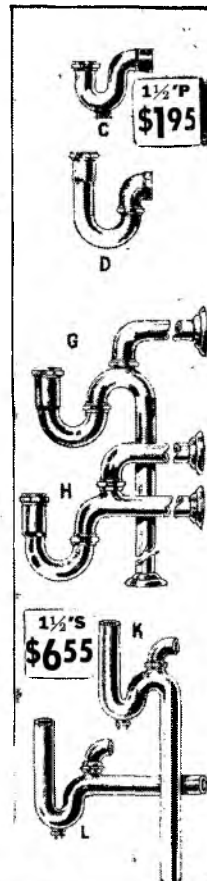

## STRAINERS FOR SINKS, LAVATORIES AND URINALS

- (A) Duplex Sink Strainer with tailpiece, 2 1/2" top. Chrome plated. .... \$1.15
- (B) New Duplex Sink Strainer with tailpiece, 4 1/2" top. Removable strainer plate. Chrome plated. .... \$1.55
- (C) Double Duty Sink Strainer with tailpiece. Serves also as stopper. Removable basket. Top 4 1/2". Stainless steel ..... \$3.48
- (D) Lavatory Strainer with chain and stopper. Chrome-plated, 1-piece construction ..... 98c  
Chrome-plated, 2-piece construction ..... \$1.25  
Chrome-plated, extra long ..... 1.85
- (E) Beehive Urinal Strainer with tailpiece and locknut. .... \$1.62

- Bathtub Waste**  
A combination waste and overflow for bathtubs incl. chain, stopper and gaskets.  
Chrome plated. .... \$4.40
- Parts**  
Shoe with casing ..... \$1.48  
Tee ..... 1.58  
Overflow strainer ..... .30  
Overflow strainer bolt ..... .18

- Casing and Fittings**  
We carry a complete stock of 1 1/4", 1 1/2" and 1 3/4" casing, together with fittings, in both slip joint and solder patterns. If you do not find what you want in this catalog, visit our store. We have everything in plumbing.



- (A) **Extension Piece**  
For extending traps and casing.  
1 1/4" to solder. .... 68c    1 1/4" slip joint. .... \$1.06  
1 1/2" to solder. .... 78c    1 1/2" slip joint. .... 1.12
- (B) **Trap Offset**  
1 1/4" ..... \$1.56    1 1/2" ..... \$1.98
- (C) **Strainer Tailpiece**  
Fits all types of sink strainers.  
Short ..... 38c    Long ..... 63c
- (D) **Funnel Tailpiece**  
For laundry trays and old style sinks ..... 49c



## CLOSET REPAIRS

- (A) **Ball Cock**  
Fits any closet tank without changing supply pipe. Sturdy bronze construction. Double lever, positive action. Easily re-washed. Includes float rod, coupling nut and washers. .... \$1.55
- (B) **Ball Cock**  
Mansfield pattern. Highly popular in some sections. Fits all closets and tanks without changing supply pipe. Bronze, carefully machined. Repair parts carried in stock. Includes float rod, coupling nut and washers. .... \$1.95
- (C) **Flush Valve**  
Improved Douglas pattern. Fits all closet tanks. Simple design, positive action. Includes overflow tube, guide, nuts and washers. .... \$1.55
- (D) **Flush Ball**  
High grade rubber, long service.  
2 1/4" ..... 29c    2" ..... 35c    2 3/4" ..... 35c    3" ..... 45c
- (E) **Ball Wires**  
Lower tank wire, connects to rubber flush ball. .... 4c  
Upper tank wire connects to trip lever. .... 6c
- (F) **Overflow Tube**  
Fits various types of flush valves. Made of copper for long service.  
1" ..... 36c    1 1/4" ..... 44c    1 1/2" ..... 49c
- (G) **Wire Guide**  
Slips on over overflow tube, guides tank wires. Bronze.  
1" ..... 35c    1 1/4" ..... 40c    1 1/2" ..... 45c
- (H) **Float Ball**  
Leakproof. Made of Copper.  
4x5" ..... 29c    5" ..... 55c
- (I) **Float Rod**  
Connects float ball to ball cock. Brass. .... 10c
- (J) **Tank Lever**  
Brass. Efficient. Easy to install. Complete with ornamental chrome handle. .... 78c
- (K) **Flush Elbows**  
Connects tank to bowl. Brass plated. Less nuts and washers.  
4x6" ..... \$ .98    5x7" ..... \$1.35  
6x8" ..... \$1.70    7x9" ..... \$1.90
- (L) **Flush Offsets**  
Connects tank to bowl. Brass, chrome plated. Less nuts and washers. 6" long, offset distance as listed.  
1" ..... \$1.45    1 1/2" ..... \$1.60  
2" ..... 1.75    2 1/2" ..... 1.95
- (M) **Closet Spuds**  
Brass with nuts and washers.  
Reg. Sanitas pat. .... 68c  
Spud Reducer ..... 75c  
Spud Increaser ..... 85c
- (N) **Closet Screws and Bolts**  
Brass with nickel-pltd. nuts and washers.  
Closet Screw ..... 6c  
Closet Bolt ..... 9c
- (O) **Seat Hinge**  
Well constructed. Fits any toilet seat. Chrome plated. Easily attached. .... 98c

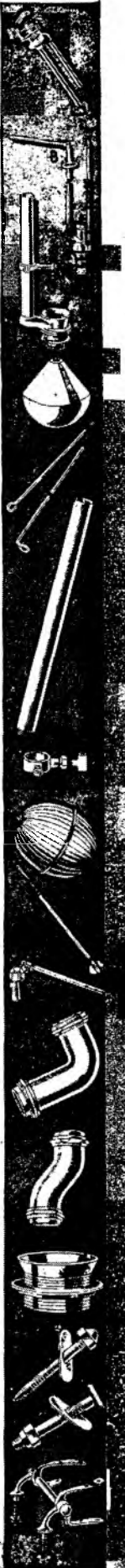

10,000 ITEMS . . . AND EVERY ONE FAIRLY PRICED

# COPPER OUTLIVES THE PYRAMIDS

Before the pyramids were built, copper pipe was used in crude form. Recent excavations on the island of Crete unearthed copper piping in good condition after thousands of years. Copper piping at our low prices will cost you very little more than rustable forms of piping. Consider carefully the different forms of rust-proof piping

on this page. Compare prices with other types and you will find it will pay to install copper for permanency, clean water and trouble-free efficient service. At our low price everyone can enjoy a permanent, rust-proof water supply.

## STRATELINE COPPER TUBING

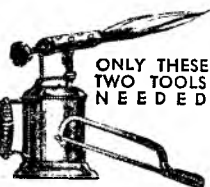

ONLY THESE TWO TOOLS NEEDED

The latest development in copper piping is the Strateline system in which are used tubes of ample weight and slim, neat fittings. Joints are made by sweat soldering. The fitting is placed in position and heated with a torch. At the proper temperature, the solder, when held to the joint, will flow evenly and completely throughout the joint, regardless of position. Strateline copper is made in three weights: M (light), L (medium) and K (heavy). L and K are recommended for general

plumbing use. L tests 2000 lbs. bursting pressure. Strateline copper tubing is 99.9% pure virgin copper. It is proof against rust and corrosion, which means clean water, no clogged pipes or expensive repairs. Fittings are of heavy red brass, designed for strength and trim appearance. A fitting for every requirement will be found in our complete stock. If you cannot make your own estimate from this catalog, bring in your sketch and we will estimate the job for you. All sizes and weights conform to Government specifications.

SOLDER FLOWS UP AUTOMATICALLY LIKE WATER IN A SPONGE

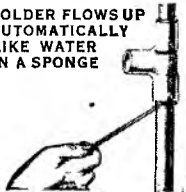

### COPPER TUBING — PRICE PER FOOT

| Type and Weight | 1/2" | 3/4" | 1"  | 1 1/4" | 1 1/2" | 2"     |
|-----------------|------|------|-----|--------|--------|--------|
| L—Medium.....   | 19¢  | 28¢  | 39¢ | 49¢    | 59¢    | 90¢    |
| K—Heavy.....    | 22¢  | 38¢  | 47¢ | 54¢    | 69¢    | \$1.02 |

### FITTINGS

|  | 1/2"   | 3/4"   | 1"     | 1 1/4" | 1 1/2" | 2"     |
|--|--------|--------|--------|--------|--------|--------|
| (A) Elbow (Ell), copper to copper          | \$0.17 | \$0.28 | \$0.61 | \$0.78 | \$1.06 | \$1.53 |
| (A) Ell, cop. to cop., reducing            |        | .33    | .61    |        |        |        |
| (B) Ell, cop. to female thread             | .19    | .33    | .61    | .78    | 1.06   | 1.53   |
| (B) Ell, cop. to fem. th., reducing        | .19    | .33    |        |        |        |        |
| (C) Ell, cop. to male thread               | .19    | .33    | .61    | .78    | 1.06   | 1.53   |
| (D) Ell, cop. to solder fitting            | .19    | .33    | .61    | .78    | 1.06   | 1.53   |
| (E) 45° Ell, cop. to cop.                  | .19    | .33    | .61    | .78    | 1.06   | 1.53   |
| (F) 45° Ell, cop. to solder fitting        | .19    | .33    | .61    | .78    | 1.06   | 1.53   |
| (G) Lug Ell, cop. to fem. thread           | .30    |        |        |        |        |        |
| (H) Sink Ell, cop. to fem. thread          | .59    |        |        |        |        |        |
| (I) Tee, all cop.                          | .25    | .45    | .84    | 1.06   | 1.53   | 2.13   |
| (J) Tee, all cop., reducing                | .29    | .54    | .84    |        |        |        |
| (J) Tee, cop. to female thread             | .29    | .54    | .84    | 1.06   | 1.53   | 2.13   |
| (J) Tee, cop. to fem. th., reducing        | .29    | .54    | .84    | 1.06   | 1.53   | 2.13   |
| (K) Stop and Waste, cop. to cop.           | .99    | 1.19   |        |        |        |        |
| (L) Adapter, cop. to male thread           | .17    | .25    | .51    | .70    | .97    | 1.39   |
| (M) Adapter, cop. to fem. thread           | .17    | .25    | .51    | .70    | .97    | 1.39   |
| (N) Adapter, cop. to fem. th., red.        | .19    | .30    | .51    |        |        |        |
| (N) Coupling, cop. to cop.                 | .13    | .20    | .27    | .28    | .35    | .63    |
| (N) Coupling, cop. to cop., red'ng         |        |        |        |        |        |        |
| (O) Union, cop. to cop.                    | .98    | 1.44   |        |        |        |        |
| (P) Boiler Cplg., cop. to male th.         |        |        | .59    |        |        |        |
| (Q) Boiler Cplg., cop. to male th.         |        |        | .68    |        |        |        |
| (R) Tubing Cap, copper                     | .13    | .20    |        |        |        |        |
| (S) Adapter, solder fitting to fem. thread | .17    | .25    | .51    | .70    | .97    | 1.39   |
| (T) Strap, copper                          | .05    | .07    |        |        |        |        |
| (U) Wire Solder, pound spool               |        |        |        |        |        | .95    |
| (V) Solder Paste, 2-ounce can              |        |        |        |        |        | .15    |

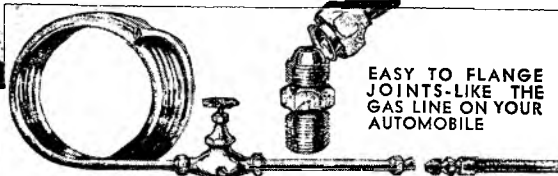

EASY TO FLANGE JOINTS-LIKE THE GAS LINE ON YOUR AUTOMOBILE

## "PERMA" COPPER TUBING

This tubing, which conforms to Government specifications, is of the same sizes and weight as Strateline copper tubing, differing only in the fact that it bends easily. It can be used in more difficult places and with fewer fittings. It is used largely for water service lines from mains to buildings and is ideal for installations between walls and floors as it can be "fished" through close places. "Perma" fittings require no solder—they are attached to tubing by flaring the tubing ends. Only four tools are needed: hacksaw, flaring tool, hammer and wrench. Strateline solder fittings can also be used, as "Perma" and Strateline tubings are of the same diameters. With either type of fitting, no expensive cutting and threading tools are required. Type L and K are recommended for inside of buildings—type K for underground use. Visit our store and let us show you how easy it is to install "Perma" copper tubing.

(L:Medium Weight K:Heavy Weight)

### PRICE PER FOOT

| Type and Weight | 1/2" | 3/4" | 1"  |
|-----------------|------|------|-----|
| L—Medium.....   | 19¢  | 28¢  | 39¢ |
| K—Heavy.....    | 22¢  | 38¢  | 47¢ |

### "PERMA" FITTINGS

(Abbreviation: C—Copper, th.—thread, coup.—coupling, Un.—Union)

|                         | 1/2"   | 3/4"   | 1"     |
|-------------------------|--------|--------|--------|
| (A) Adapter, C to th.   | \$0.42 | \$0.56 | \$1.06 |
| (B) Adapter, C to th.   | .42    | .56    | 1.06   |
| (C) Coup., C to C       | .42    | .56    | 1.06   |
| (D) Union, C to C       | .56    | .93    | 1.39   |
| (E) Elbow, C to C       | .56    | .93    |        |
| (F) Elbow, C to th.     | .56    | .93    |        |
| (G) Lug El., C to th.   | .93    |        |        |
| (H) Tee, all copper     | .93    | 1.25   |        |
| (I) Tee, C to th.       | .93    | 1.25   |        |
| (J) Boiler Un. C to th. |        |        | .65    |
| (K) Boiler Un. C to th. |        |        | .97    |
| (L) Fitting Reducer     |        | .65    |        |
| (M) Corporation coup.   | 1.21   | 1.21   | 1.75   |
| (N) Flaring Tool        | .51    | .65    | .83    |
| (O) Stop and Waste      |        |        |        |
| (P) Valve               | 1.76   | 2.13   |        |
| (P) Curb Cock           |        | 4.15   | 6.30   |

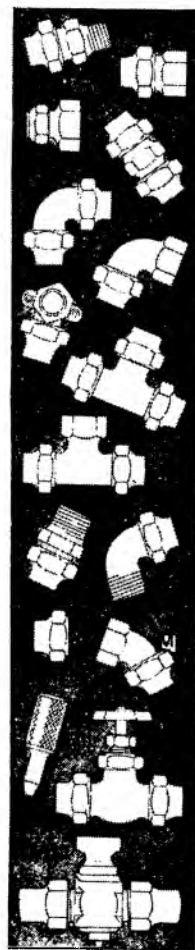

## COPPER PIPE

Full weight in the same thickness, diameter, and threading as steel pipe. Being rust-proof, it will add to the value of your house. It is seamless and can be bent and shaped without opening up. Designed for stress and maximum service. Can be furnished in 12-ft. lengths, or we shall cut and thread it to your exact measurements.

| Copper Pipe, per 12-ft. length... | 3/8"   | 1/2"   | 3/4"   | 1"     | 1 1/4"  | 1 1/2"  | 2"      |
|-----------------------------------|--------|--------|--------|--------|---------|---------|---------|
| per ft. in cut pcs....            | \$3.78 | \$5.30 | \$6.99 | \$9.72 | \$14.39 | \$17.10 | \$22.62 |
| Chrome Plated Pipe, per ft.....   | .56    | .74    |        |        |         |         |         |
| Threading, each end.              | .09    | .09    | .12    | .14    | .18     | .21     | .27     |

### Brass and Copper Nipples

| Lg..... | 3/8" | 1/2" | 3/4" | 1"  | 1 1/4" | 1 1/2" | 2"   |
|---------|------|------|------|-----|--------|--------|------|
| AT..... | .10  | .11  | .15  | .21 | .27    | .33    | .46  |
| 2"..... | .12  | .15  | .18  | .25 | .36    | .42    | .46  |
| 3"..... | .15  | .20  | .26  | .35 | .42    | .49    | .65  |
| 4"..... | .19  | .25  | .33  | .45 | .55    | .64    | .84  |
| 5"..... | .23  | .31  | .40  | .55 | .67    | .78    | 1.03 |
| 6"..... | .29  | .37  | .48  | .67 | .79    | .91    | 1.23 |

### Chrome Nipples

| Lg..... | 3/8" | 1/2" | 3/4" | 1" | 1 1/4" | 1 1/2" | 2" |
|---------|------|------|------|----|--------|--------|----|
| AT..... | .14  | .22  |      |    |        |        |    |
| 2"..... | .22  | .29  |      |    |        |        |    |
| 3"..... | .29  | .38  |      |    |        |        |    |
| 4"..... | .37  | .48  |      |    |        |        |    |
| 5"..... | .45  | .57  |      |    |        |        |    |
| 6"..... | .52  | .67  |      |    |        |        |    |

## BRASS FITTINGS

|                           | 3/8"   | 1/2"   | 3/4"   | 1"     | 1 1/4" | 1 1/2" | 2"     |
|---------------------------|--------|--------|--------|--------|--------|--------|--------|
| (A) Elbow.....            | \$0.17 | \$0.22 | \$0.32 | \$0.54 | \$0.78 | \$0.97 | \$1.57 |
| (B) Tee.....              | .24    | .30    | .43    | .76    | .97    | 1.33   | 2.18   |
| (C) Coupling.....         | .17    | .22    | .29    | .43    | .61    | .82    | 1.36   |
| (D) Union.....            | .55    | .66    | .92    | 1.21   | 1.59   | 1.89   | 2.90   |
| (E) 45° Elbow.....        | .19    | .24    | .35    | .59    | .85    | 1.07   | 1.73   |
| (F) Street Elbow.....     | .26    | .32    | .46    | .75    | 1.04   | 1.36   | 2.30   |
| (G) 45° Street Elbow..... | .26    | .32    | .46    | .75    | 1.04   | 1.36   | 2.30   |
| (H) Lug Elbow.....        | .52    | .59    | .87    |        |        |        |        |
| (I) Sink Elbow.....       | .59    |        |        |        |        |        |        |
| (J) Side Outlet Ell.....  | .71    | 1.03   |        |        |        |        |        |
| (K) Bushing.....          | .11    | .13    | .19    | .29    | .44    | .56    | .82    |
| (L) Cap.....              | .13    | .17    | .23    | .36    |        |        |        |
| (M) Plug.....             | .11    | .18    | .20    | .27    |        |        |        |
| (N) Cross.....            |        | .48    |        |        |        |        |        |
| (O) Reducing Tee.....     | .31    | .39    | .57    | .99    | 1.26   | 1.70   | 2.83   |
| (P) Side Outlet Tee.....  |        | 1.60   |        |        |        |        |        |
| (Q) Reducing Couplg.....  | .18    | .23    | .34    | .57    | .82    | 1.04   | 1.55   |
| (R) Reducing Elbow.....   | .26    | .28    | .38    | .67    | .92    | 1.16   | 2.06   |
| (S) Extension Piece.....  | .41    | .53    | .76    |        |        |        |        |
| (T) Crossover.....        |        | .58    |        |        |        |        |        |

All commonly used fittings can be furnished in chrome at slightly higher prices.



# USE OUR COMPLETE PIPE SERVICE

In our complete stock of pipe and fittings, you will find anything you need for water supply, drainage, sewer, heating, gas, irrigation, railing, structural, industrial or other piping. We maintain a service for cutting and threading pipe to your exact measurement or sketch of installation.

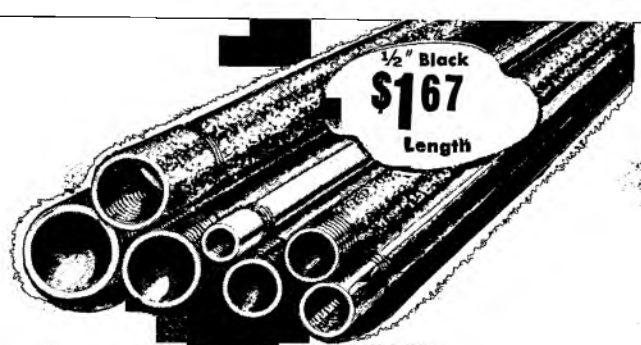

## STEEL PIPE

Our steel pipe is made in the nation's best known mills of high quality steel and the latest scientific methods. It is of uniform thickness—cuts and threads easily and every length is full weight. Each length is carefully inspected and tested under severe hydraulic pressure. Galvanized pipe is cleaned in an acid bath and then coated inside and out with pure molten zinc. It is accurately threaded by machine. Each full length is

furnished with full threads on each end and one coupling without extra charge. Pipe cut and threaded to your measurements carries a slight additional charge. As of the time this catalog is printed, steel pipe is extremely scarce, and we may not be able to meet your requirements at all times. Please bear with us and call again.

### DRAINAGE FITTINGS

Heavy cast iron fittings recessed to form smooth waterways. Well galvanized inside and out.

**a. Long Turn Elbow, 90°**  
 1 1/4" .56 1 1/2" .66 2" .1.03  
 1 1/2"x1 1/4" .72 2x1 1/2" .1.06

**b. Long Turn Elbow, 45°**  
 1 1/4" .56 1 1/2" .66 2" .1.08

**c. Street Elbow, 90°**  
 1 1/4" .56 1 1/2" .66 2" .1.08

**d. Street Elbow, 45°**  
 1 1/4" .56 1 1/2" .66 2" .1.08

**e. Long Turn Elbow, 60°**  
 1 1/4" .62 1 1/2" .72 2" .1.09

**f. Elbow, 22 1/2°**  
 1 1/4" .62 1 1/2" .72 2" .1.09

**g. Elbow, 11 1/4°**  
 1 1/4" .62 1 1/2" .72 2" .1.09

**h. Elbow, 5 1/2°**  
 1 1/4" .62 1 1/2" .72 2" .1.09

**i. Long Turn T-Y**  
 1 1/4" .1.08 1 1/2" .1.31 2" .2.28  
 1 1/2"x1 1/4" .1.48 2x1 1/2" .2.46

**j. Y Branch, 45°**  
 1 1/4" .80 1 1/2" .1.14 2" .1.85  
 1 1/2"x1 1/4" .1.22 2x1 1/2" .2.02

**k. Long Turn Cross**  
 1 1/2" .1.99 2" .3.31  
 1 1/2"x1 1/4" .2.22 2x1 1/2" .3.71

**l. Coupling**  
 1 1/4" .71 1 1/2" .83 2" .1.03

**m. "P" Trap**  
 1 1/2" .1.48

### STRINGER DRAINAGE FITTINGS

Top opening hub pattern for caulking—galvanized.

**n. Elbow, 90°**  
 1 1/4" .90 1 1/2" .90 2" .1.42

**o. Sanitary Tee**  
 1 1/4" .1.26 1 1/2" .1.26 2" .2.36

**p. Sanitary Cross**  
 1 1/2" .2.16 2" .2.88  
 1 1/2"x1 1/4" .2.16 2x1 1/2" .2.88

**q. Coupling**  
 1 1/4" .1.08 1 1/2" .1.24 2" .1.42

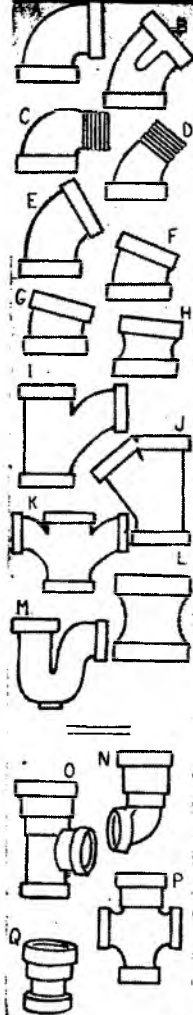

## Lawn SPRINKLERS

Bury pipe or copper tubing a few inches underground and space sprinkler heads throughout your yard or garden, and you have an automatic sprinkling system that is turned on or off with a twist of a valve handle. No hose to drag out, no attention needed. Each sprinkler covers approximately 100 sq. ft. with a fine misty spray. Bring us a sketch of your yard and we will let you know the amount of tubing and number of sprinklers you need. Solid brass, rust-proof lawn sprinklers, each **69c**

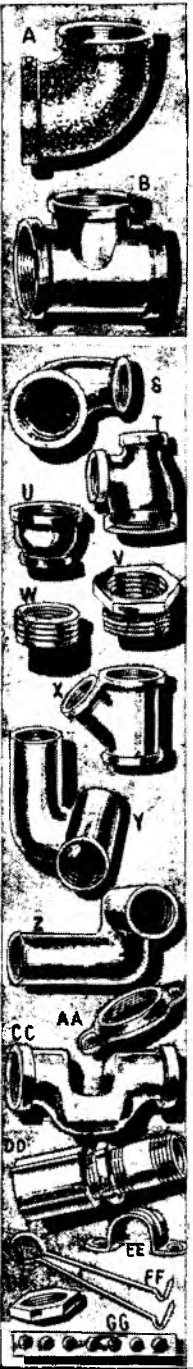

### BLACK AND GALVANIZED STEEL PIPE

|                             | 3/8"   | 1/2"   | 3/4"   | 1"     | 1 1/4" | 1 1/2" | 2"     |
|-----------------------------|--------|--------|--------|--------|--------|--------|--------|
| Black, 21-ft. length.....   | \$1.47 | \$1.47 | \$1.47 | \$1.67 | \$2.52 | \$3.57 | \$4.83 |
| Galv., 21-ft. length.....   | 1.68   | 1.68   | 1.68   | 2.52   | 2.94   | 4.41   | 6.09   |
| Black, cut pcs. per ft..... | .08    | .08    | .08    | .12    | .13    | .18    | .29    |
| Galv., cut pcs. per ft..... | .09    | .09    | .09    | .13    | .15    | .22    | .31    |
| Threading—per end.....      | .05    | .05    | .05    | .06    | .09    | .11    | .16    |

Larger Sizes  
Prices on  
Application.

### BLACK AND GALVANIZED MALLEABLE FITTINGS

Highest grade castings, fully annealed, carefully machined, full deep tapered threads. All outlets chamfered. Designed for secure gripping by wrench. Galvanized fittings well coated inside and out.

| SIZE INCHES                       | PRICES, EACH      |        |                     |        |        |        |        |  |
|-----------------------------------|-------------------|--------|---------------------|--------|--------|--------|--------|--|
|                                   | 3/8"              | 1/2"   | 3/4"                | 1"     | 1 1/4" | 1 1/2" | 2"     |  |
| (A) Elbow, (ell) black.....       | \$1.10            | \$1.10 | \$1.10              | \$1.13 | \$1.16 | \$2.26 | \$4.41 |  |
| (A) Elbow, (ell) galv.....        | .13               | .13    | .13                 | .13    | .19    | .26    | .41    |  |
| (B) Tee, black.....               | .14               | .14    | .14                 | .18    | .23    | .40    | .63    |  |
| (B) Tee, galv.....                | .18               | .18    | .18                 | .21    | .30    | .40    | .63    |  |
| (C) St. Ell, black.....           | .14               | .14    | .14                 | .16    | .23    | .34    | .53    |  |
| (C) St. Ell, galv.....            | .18               | .18    | .18                 | .21    | .30    | .34    | .53    |  |
| (D) Union, black.....             | .47               | .47    | .47                 | .50    | .55    | .72    | .99    |  |
| (D) Union, galv.....              | .53               | .53    | .53                 | .49    | .59    | .94    | 1.29   |  |
| (E) 45° Ell, black.....           | .12               | .12    | .12                 | .13    | .18    | .29    | .50    |  |
| (E) 45° Ell, galv.....            | .16               | .16    | .16                 | .18    | .25    | .29    | .50    |  |
| (F) 45° St. Ell, black.....       | .07               | .07    | .07                 | .09    | .12    | .14    | .19    |  |
| (F) 45° St. Ell, galv.....        | .07               | .07    | .07                 | .09    | .12    | .14    | .19    |  |
| (G) Coupling, black.....          | .07               | .07    | .07                 | .08    | .12    | .16    | .27    |  |
| (G) Coupling, galv.....           | .09               | .09    | .09                 | .10    | .15    | .20    | .34    |  |
| (H) Cap, black.....               | .07               | .07    | .07                 | .09    | .12    | .14    | .19    |  |
| (H) Cap, galv.....                | .05               | .05    | .05                 | .05    | .06    | .07    | .10    |  |
| (J) Lug Ell, galv.....            |                   |        | .23                 | .26    |        |        |        |  |
| (K) Side Outlet Ell, galv.....    |                   |        | .29                 | .33    | .36    | .55    | .72    |  |
| (L) Lug Tee, galv.....            |                   |        | .39                 |        |        |        |        |  |
| (M) Side Outlet Tee, galv.....    |                   |        | .33                 | .40    | .50    | .66    | .91    |  |
| (N) Cross, galv.....              |                   |        | .35                 | .45    | .53    | .66    | .91    |  |
| (O) Y, galv.....                  |                   |        |                     |        |        | .97    | 1.35   |  |
| (P) Extension Piece, galv.....    |                   |        | .23                 | .25    | .33    | .41    |        |  |
| (Q) Flange, black.....            | .22               | .22    | .27                 | .27    | .34    | .34    | .43    |  |
| (R) Rt. & Left Coup., black.....  |                   |        | .13                 | .13    | .16    | .23    | .31    |  |
| (R) Rt. & Left Nipple, black..... |                   |        | .10                 | .10    | .13    | .17    | .20    |  |
| (S) Reducing Ell, black.....      |                   |        | .16                 | .18    | .23    | .28    | .48    |  |
| (S) Reducing Ell, galv.....       |                   |        | .16                 | .18    | .23    | .28    | .48    |  |
| (T) Reducing Tee, black.....      |                   |        | .19                 | .25    | .33    | .44    | .69    |  |
| (T) Reducing Tee, galv.....       |                   |        | .19                 | .25    | .33    | .44    | .69    |  |
| (U) Reducing Coup., black.....    |                   |        | .11                 | .11    | .15    | .18    | .28    |  |
| (U) Reducing Coup., galv.....     |                   |        | .14                 | .14    | .15    | .18    | .28    |  |
| (V) Bushing, black.....           |                   | .08    | .08                 | .09    | .10    | .12    | .14    |  |
| (V) Bushing, galv.....            |                   | .12    | .12                 | .14    | .15    | .18    | .22    |  |
| (W) Face Bushing, galv.....       |                   |        |                     |        |        |        | .47    |  |
| (X) Reducing Y, galv.....         |                   |        |                     |        |        |        | 1.59   |  |
| (Y) Wash Tray Tee, galv.....      |                   |        |                     | .54    |        |        |        |  |
| (Z) Wash Tray Ell, galv.....      |                   |        |                     | .54    |        |        |        |  |
| (AA) Waste Nut, galv.....         |                   |        | .12                 | .14    | .16    |        |        |  |
| (BB) Lock Nut, galv.....          |                   |        | .06                 | .07    | .09    | .11    | .14    |  |
| (CC) Crossover, galv.....         |                   |        |                     | .46    |        |        |        |  |
| (DD) Longscrew, galv.....         |                   |        |                     |        |        | 1.25   | 1.62   |  |
| (EE) Strap, galv., doz.....       |                   | .15    | .15                 | .25    | .30    | .35    | .40    |  |
| (FF) Pipe Hook, doz.....          |                   |        | .25                 | .25    | .30    | .40    | .40    |  |
| (GG) Hanger Iron.....             | 5 ft. length \$35 |        | 10 ft. length \$55. |        |        |        |        |  |

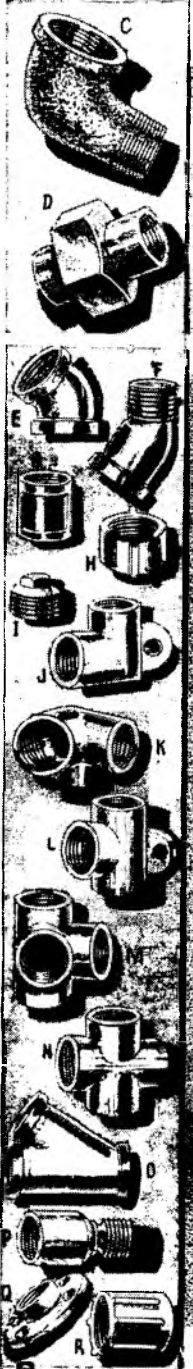

### BLACK STEEL NIPPLES

| Pipe Size        | 3/8"  | 1/2"  | 3/4"  | 1"    | 1 1/4" | 1 1/2" | 2"    |
|------------------|-------|-------|-------|-------|--------|--------|-------|
| ALL THREAD.....  | \$.07 | \$.07 | \$.07 | \$.07 | \$.09  | \$.12  | \$.14 |
| 2 ins. long..... | .07   | .07   | .07   | .07   | .08    | .11    | .13   |
| 3 ins. long..... | .08   | .08   | .08   | .09   | .09    | .12    | .15   |
| 4 ins. long..... | .09   | .09   | .09   | .10   | .11    | .13    | .17   |
| 5 ins. long..... | .10   | .10   | .10   | .11   | .12    | .14    | .22   |
| 6 ins. long..... | .11   | .11   | .11   | .12   | .12    | .16    | .21   |

### GALVANIZED STEEL NIPPLES

| Pipe Size        | 3/8"  | 1/2"  | 3/4"  | 1"    | 1 1/4" | 1 1/2" | 2"    |
|------------------|-------|-------|-------|-------|--------|--------|-------|
| ALL THREAD.....  | \$.07 | \$.07 | \$.07 | \$.07 | \$.08  | \$.10  | \$.13 |
| 2 ins. long..... | .07   | .07   | .07   | .07   | .08    | .09    | .13   |
| 3 ins. long..... | .09   | .09   | .09   | .10   | .11    | .14    | .19   |
| 4 ins. long..... | .11   | .11   | .11   | .11   | .13    | .16    | .20   |
| 5 ins. long..... | .12   | .12   | .12   | .12   | .14    | .17    | .22   |
| 6 ins. long..... | .13   | .13   | .13   | .14   | .15    | .21    | .26   |

# EVEN ON THE SCARCEST ITEMS — WE'VE KEPT PRICES DOWN

The scarcity of an item has never been a factor in setting our prices. When soil pipe was selling at \$10.00 a foot in many places, we still kept the rock-bottom prices you see on this page. We intend to be

in business for a long time, and we believe you will remember companies like ourselves that didn't take advantage of shortages. That's why we have always kept the same low prices regardless of whether the material was plentiful or "hard-to-get."

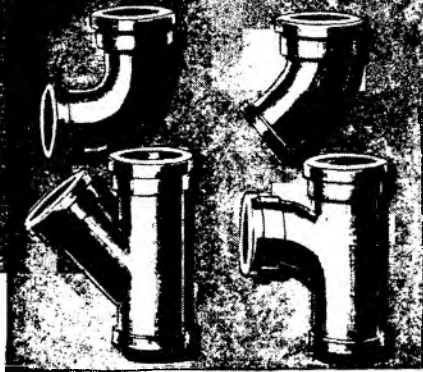

**STANDARD WEIGHT SOIL PIPE FITTINGS**

|          | 2"     | 3"     | 4"     | 6"     |
|----------|--------|--------|--------|--------|
| 1/4 Bend | \$.075 | \$.087 | \$1.39 | \$2.14 |
| 1/2 Bend | .65    | .79    | 1.09   | 1.86   |
| Y Branch | .98    | 1.34   | 1.98   | 3.59   |
| San. Tee | .98    | 1.34   | 1.98   | 3.59   |



**(A) Sixth Bend**

|    | 2"  | 3"  | 4"   | 6"   |
|----|-----|-----|------|------|
| 2" | .59 | .91 | 1.16 | 1.97 |
| 4" | .59 | .91 | 1.16 | 1.97 |

**(A) Sixteenth Bend**

|    | 2"  | 3"  | 4"   | 6"   |
|----|-----|-----|------|------|
| 2" | .59 | .91 | 1.16 | 1.97 |
| 4" | .59 | .91 | 1.16 | 1.97 |

**(B) Long Quarter Bend**

|    | 4x18   |
|----|--------|
| 4" | \$2.19 |

**(C) Long Sweep 1/4-Bend**

|    | 4"     |
|----|--------|
| 4" | \$2.09 |

**(D) 1/4-Bend, Side Inlet**

|     | Right or left hand |
|-----|--------------------|
| 4x2 | \$1.86             |

**(E) 1/4-Bend, Heel Inlet**

|     | 4x2    |
|-----|--------|
| 4x2 | \$1.86 |

**(F) Double Quarter Bend**

|    | 4"     |
|----|--------|
| 4" | \$3.49 |

**(G) Reducing Sanitary Tee**

|  | 3x2    | 4x2    | 3x3x4  |
|--|--------|--------|--------|
|  | \$1.31 | \$1.59 | \$1.63 |

**(H) Tapped Sanitary Tee**

|  | Tappings 1 1/2", 1 1/2" or 2" | 2"     | 3"     | 4" |
|--|-------------------------------|--------|--------|----|
|  | \$1.07                        | \$1.42 | \$1.75 |    |

**(I) Tapped Vent Tee**

|  | Tappings 1 1/2", 1 1/2" or 2" | 2"     | 3"     | 4" |
|--|-------------------------------|--------|--------|----|
|  | \$1.37                        | \$1.72 | \$2.05 |    |

**(J) Sanitary Tee, Side Inlet**

|  | 2"     | 3"     | 4"     |
|--|--------|--------|--------|
|  | \$1.79 | \$2.75 | \$3.49 |

**(K) Reducing Y Branch**

|  | 3x2    | 4x2    |
|--|--------|--------|
|  | \$1.31 | \$1.59 |

**(L) Double Y Branch**

|  | 2"     | 3"     | 4" |
|--|--------|--------|----|
|  | \$1.86 | \$2.74 |    |

**(M) Comb. Y and 1/4-Bend**

|  | 4"     |
|--|--------|
|  | \$2.98 |

## SOIL PIPE YOU CAN DEPEND UPON



Cast iron soil pipe is far more satisfactory for sewers than clay tile. It does not sag or crack. When the joints

of cast iron pipe are properly caulked, roots cannot enter to clog the sewer. Our pipe is made of close-grained, dense, full-weight cast iron. Walls of uniform thickness. Easily cut with a cold chisel. All pipe and fittings are extra heavy weight and will conform to even the strictest local plumbing codes.

### SOLD IN FIVE-FOOT LENGTHS

By cutting double hub pipe for short lengths, each length has a hub.

|                        | 2"     | 3"     | 4"     | 6"     |
|------------------------|--------|--------|--------|--------|
| Single hub, per length | \$2.49 | \$2.89 | \$3.98 | \$6.09 |
| Double hub, per length | 2.69   | 3.09   | 4.19   | 7.49   |

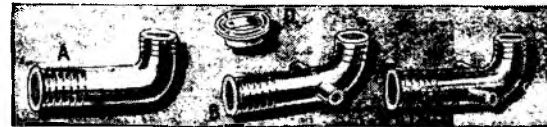

### CAST IRON CLOSET BENDS

(A) Plain Closet Bend with collar or flange ..... \$2.39  
 (B) Closet Bend, 2 tappings 90°, 1 1/2" or 2" col. or fl. .... 2.74  
 (C) Closet Bend, 2 tappings 45°, 1 1/2" or 2" col. or fl. .... 3.18  
 (D) Closet flange or slip collar only ..... .39

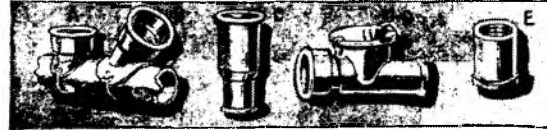

### SOIL PIPE SADDLES

**(A) Tee Hub Pattern**

|  | 2"     | 4x2    | 4"     |
|--|--------|--------|--------|
|  | \$1.12 | \$1.29 | \$1.29 |

**(B) Y Hub Pattern**

|  | 2"     | 4x2    | 4"     |
|--|--------|--------|--------|
|  | \$1.12 | \$1.29 | \$1.29 |

**(C) Sisson Insertable Joint**

|    | Insert in Soil Stack for Repairs or Additions. |
|----|--|
| 2" | \$2.08   |
| 4" | \$2.74   |

**(D) Backwater Trap**

|  | For flood protection |
|--|----------------------|
|  | \$8.40               |

**(E) Caulking Sleeve**

|  | Takes 1 1/2" or 2" threaded pipe, fits 2" hub |
|--|---|
|  | .99c  |

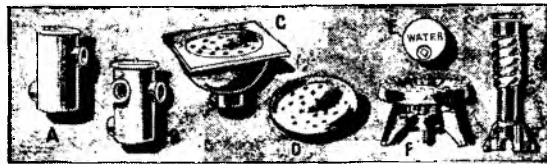

(A) Drum Trap, 4x5", two openings tapped 1 1/2", with cover, \$2.17  
 (A) Drum Trap, 4x8", two openings tapped 1 1/2", with cover, 2.49  
 (A) Drum Trap, 4x10", two openings tapped 1 1/2", with cover, 3.27  
 (B) Drum Trap, 4x8", three openings tapped 1 1/2", with cover, 2.85  
 (B) Drum Trap, 4x10", three openings tapped 1 1/2", with cover, 3.60  
 (C) Bell Trap Floor Drains, 6x6, 98c; 9x9, \$1.75; 12x12, \$2.90  
 (D) Grating to fit Bell Trap, 6x6, 32c; 9x9, 59c; 12x12, 71c  
 (E) Curb Box Lid .....  
 (C) Curb Box, adjustable, 3 to 4 ft., with lid and bolt, .... \$3.95

### CODE SPECIALTIES AND SUPPLIES

(A) Pittsburgh House Trap 6x4x4 6x6x4  
 Ex. Heavy ..... \$14.88 \$14.88  
 (B) Sanitary Tee, one 45° threaded opening on each side, tapped 1 1/2" or 2"  
 3x3x4 4x4x4  
 \$7.44 \$7.44  
 (C) Fresh Air Inlet, for inside caulking, 4" ..... \$2.03  
 (D) Bell Trap Floor Drain, for inside caulking, 9x9, \$2.49  
 12x12, 4.49  
 (E) Oakum, 1 lb. .... 29c  
 5 lb. .... \$1.25 50 lb. .... \$10.95  
 (F) Caulking Lead, per 5-lb. pig. .... \$1.27  
 (G) Plastic Lead, a leak-proof compound:  
 10-oz. can ..... \$ .49  
 22-oz. can ..... .88  
 5-lb. can ..... 2.95  
 (H) Soil Pipe Cement  
 1-lb. can ..... 25c  
 5-lb. can ..... 98c  
 (I) Roof Flashing  
 1 1/2" 1 1/2" 2" 3" 4"  
 \$1.95 \$1.95 \$2.25 \$2.55 \$2.95

**(A) 45° Offsets**

| Extra Heavy Weight To | Pipe Sizes |        |        |
|-----------------------|------------|--------|--------|
| Offset                | 2"         | 3"     | 4"     |
| 4-ins.                | \$0.89     | \$1.39 | \$1.69 |
| 6-ins.                | 1.09       | 1.49   | 1.79   |
| 8-ins.                | 1.29       | 1.79   | 1.98   |
| 10-ins.               | 1.39       | 1.99   | 2.19   |
| 12-ins.               | 1.69       | 2.29   | 2.49   |
| 14-ins.               | 1.79       | 2.49   | 2.79   |

**(B) Sanitary Cross**

|  | 2"     | 4"     |
|--|--------|--------|
|  | \$1.86 | \$2.74 |

**(C) Tapped Sanitary Cross**

| Tappings 1 1/4", 1 1/2" or 2" | 2"     | 4"     |
|-------------------------------|--------|--------|
|                               | \$1.89 | \$2.28 |

**(D) Tapped Vent Cross**

| Tappings 1 1/4", 1 1/2" or 2" | 2"     | 4"     |
|-------------------------------|--------|--------|
|                               | \$1.59 | \$1.98 |

**(E) Reducer**

|  | 3x2 | 4x2 | 4x3 | 6x4    |
|--|-----|-----|-----|--------|
|  | 69c | 79c | 89c | \$1.29 |

**(F) Increaser**

|  | 3x4    |
|--|--------|
|  | \$1.97 |

**(G) Double Hub Fitting**

|  | 2"  | 3"  | 4"  | 6"     |
|--|-----|-----|-----|--------|
|  | 75c | 83c | 98c | \$1.97 |

**(H) Sleeve**

|  | 2"  | 3"  | 4"  | 6"     |
|--|-----|-----|-----|--------|
|  | 89c | 98c | 99c | \$2.49 |

**(I) Plug**

|  | 2"  | 3"  | 4"  |
|--|-----|-----|-----|
|  | 39c | 59c | 69c |

**(J) Plain "P" Trap**

|  | 2"     | 3"     | 4"     |
|--|--------|--------|--------|
|  | \$1.39 | \$1.98 | \$2.49 |

**(K) Plain "S" Trap**

|  | 2"     | 4"     |
|--|--------|--------|
|  | \$1.39 | \$2.49 |

**(L) Plain Running Trap**

|  | 4"     |
|--|--------|
|  | \$3.98 |

**(M) "P" Trap—Hub Vent**

|  | 4"     |
|--|--------|
|  | \$3.44 |

**(N) Running Trap—Hub Vent**

|  | 4x4x4  |
|--|--------|
|  | \$3.49 |

**(O) Cleanout Plug**

|  | Iron Body with Screw Plug         |
|--|-----------------------------------|
|  | 2" 61c 3" 82c 4" \$1.05 6" \$3.15 |

**(P) Fresh Air Inlet**

|  | To Drive  |
|--|-----------|
|  | 4", \$4.5 |

**(Q) Fresh Air Inlet**

|  | To Caulk  |
|--|-----------|
|  | 4", \$4.8 |

**(R) Soil Pipe Hook**

|  | 2"     | 3"     | 4"     | 6"     |
|--|--------|--------|--------|--------|
|  | \$ .19 | \$ .20 | \$ .23 | \$ .42 |



**ADJUSTABLE CELLAR POST**

**\$7.95**

You can correct sagging floors and dangerously weak joists. Do it yourself at little cost with these adjustable steel cellar supports. They will replace present rotted cellar posts or they can be used as an extra precaution. They are made of heavy steel and can be adjusted to any cellar height from 5'7" to 8'4". Can also be used as a "jack."

**HOME INCINERATOR**

**\$58.50**

Get rid of messy, smelly, rat-breeding garbage cans full of maggots. Install a home incinerator that will burn all your wet or dry garbage and all your burnable rubbish. No fuel needed except the waste material itself. No odors. Will burn three bushels of garbage and trash at a time.

For even faster burning, this incinerator can be furnished in a gas-fired model. Full 2 bushel capacity. Easy to install—you can do it yourself in less than a half-hour. Gas-fired unit at a thrifty price of ..... \$69.50

**NOW, MORE THAN EVER, IT PAYS TO COMPARE PRICES BEFORE YOU BUY**

# YOUR ONE-STOP PLUMBING SERVICE

No need to scour the city in search of your plumbing needs. Whether it is a bath tub or a washer, sink or repair part, you will find it at our store and at money saving prices. Get acquainted with this "one-stop" service—visit our store today for anything you may need in the plumbing line.

**Drain Pipe Cleaner**  
A powerful chemical. Eats through grease, hair and other materials which clog waste lines. Does not harm pipes.  
Can. .... **29c**

**Plastic Lead**  
A leak-proof compound for soil pipe joints and general plumbing repairs. Won't shrivel, shrink or crack. Ready to use, easily applied.  
10 oz. .... **\$0.49**  
22 oz. .... **.88**  
5 lbs. .... **2.95**

**Soil Pipe Cement**  
Makes tight joints on soil pipe without tools or lead. Mix with water. Sets quickly, holds forever.  
1 lb. .... **\$0.25**  
5 lbs. .... **1.00**

**Putty**  
An all-purpose putty at lowest prices. 1 lb. .... **12c**  
5 lb. **47c** 12½ lb. **\$1.07**

**Porcelain Glaze**  
In liquid form for repairing chipped plumbing fixtures, etc.  
Bottle. .... **25c**

**Plastic Porcelain**  
Repairs cracks between walls and bath tub, also tile. Mix with water and use.  
Can. .... **35c**

**Pipe Joint Compound**  
For all threaded pipe joints. Prevents leaks—will not dry out.  
Tube. .... **29c**  
1-lb. can. .... **24c**  
5-lb. can. .... **98c**

**Cutting Oil**  
Lubricates pipe threader, keeps die from overheating and growing dull.  
Quart can. .... **50c**

**Penetrating Oil**  
Penetrates rusty joints and permits easy removal of pipe and fittings.  
Can. .... **35c**

**Solder Paste**  
An efficient flux for general soldering purposes.  
Small can. .... **15c**  
8-oz. can. .... **45c**

**Liquid Solder**  
Mends metal, glass, wood, porcelain.  
Tube. .... **35c**

**Open Clogged Drains Force Cups**  
Resilient rubber. Complete with threaded handle. 4½" .... **27c**  
5½" .... **47c** 6½" .... **77c**

**Sewer Rods**  
Flexible spring steel. Special head quickly reaches and penetrates the obstruction.  
¾" wide, 25' long. .... **\$0.98**  
1½" wide, 25' long. .... **2.75**  
1½" wide, 50' long. .... **4.95**

**Sewer Auger**  
Coiled steel high tension spring. Head has sharp hook. Crank handle forces auger to obstruction.  
10 ft. long. .... **\$1.85**  
15 ft. .... **2.49**  
25 ft. .... **3.70**

**Close Auger**  
For removing obstructions in closet bowls. Spring steel, sharp hook at the head. Crank handle. J shaped tube guides snake around trap. 3 ft. long. .... **\$1.10**



**Pipe Threaders**  
(A) A complete stock with "Kalarized" die for threading ½" pipe. Adjustable guide. (Additional dies from ½" to ¾" \$1.70 each) .... **\$4.95**  
(B) A real mechanic's stock and die for threading 1" to 2" pipe. Quickly adjustable. Best quality and workmanship. .... **\$23.70**  
(C) A ratchet type stock and die for threading pipe in close places. Excellent quality. Including ½" die, only. .... **\$9.35**

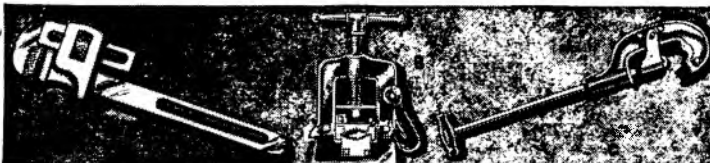

(A) Husky Pipe Wrench with Drop Forged Steel Jaws and Bulldog Grip, 6" .... **93c**  
8" .... **\$1.07** 10" .... **\$1.39** 14" .... **\$1.89** 18" .... **\$2.68** 24" .... **\$4.63**  
(B) Hinged Pipe Vise, Malleable Frame, Tempered Tool Steel Jaws, Grips Firmly. Can take pipe out sideways. Holds ½" to 1¼" pipe. .... **\$3.60**  
(C) This sturdily built tool cuts pipe easily and truly. Cutting wheel easily replaceable. No. 1 for Pipe ½" to 1" .... **\$4.35** No. 2 for Pipe ¾" to 2" .... **\$6.50**



**Tools That Every Home Owner Needs**  
(A) Bibb Seat Dresser—to renew seats of faucets and valves. .... **\$1.34**  
(B) Street Key—to turn off water or gas at the curb. .... **1.25**  
(C) Curb Box Lid Wrench—to remove bolt of curb box lid. .... **.46**

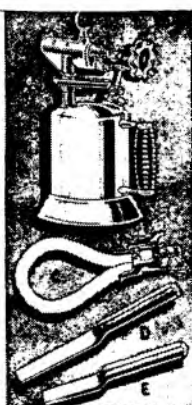

**Blow Torch (A)**  
A quality torch for plumbers, painters or home owners. Non-porous bronze burner. Heat-resisting valve wheel. Quick acting pump. Heavy brass tank. Full quart size. .... **\$6.45**

**Plumbers' Furnace (B)**  
A well-designed, strongly built gasoline furnace. Lead-coated steel tank prevents rust. All openings locked or welded. Parts easily changeable. Dependable brass pump. .... **\$12.60**

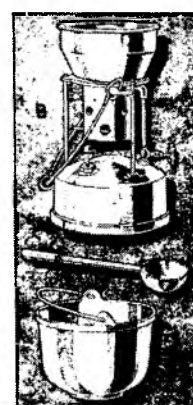

**Lead-Working Tools**  
(C) Asbestos Joint Runner—needed for pouring lead in joints of soil pipe when in horizontal position. .... **\$1.56**  
(D) Packing Iron, tool steel. .... **1.20**  
(E) Caulking Iron, tool steel. .... **.65**  
(F) Lead Pouring Ladle. 3" .... **38c** 3½" .... **40c** 4" .... **48c**  
(G) Lead Melting Pots. 5" .... **75c** 6" .... **\$1.25**



**LEAD GOODS** Due to constantly changing markets, we cannot price lead goods in this catalog. Bear in mind, however, that we maintain a complete stock of lead pipe, bends, drum traps, closet bends, sheet lead, cake lead, solder—in fact every lead plumbing item required in this section.

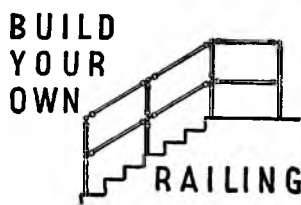

**BUILD YOUR OWN RAILING**  
With the railing fittings shown here, you can build your own railings to suit your exact requirements. If you will bring in a sketch of your job, we can cut and thread your pipe to exact size. Our engineers will be glad to assist you on your railing problems.

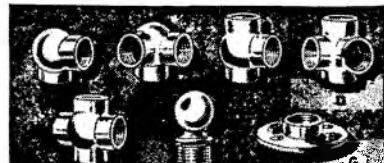

**Malleable Railing Fittings**  
(A) Elbow. .... **30c** 1¼" .... **\$1.47** 1½" .... **\$1.65**  
(B) Side Outlet Elbow. .... **60c** .96 **1.31**  
(C) Tee. .... **42c** .60 **.87**  
(D) Side Outlet Tee. .... **80c** 1.23 **1.74**  
(E) Cross. .... **54c** .82 **1.15**  
(F) Ornamental Acorn. .... **42c** .60 **.82**  
(G) Wall or Floor Flange. .... **28c** .30 **.35**

**Lead to Iron Union (A)**  
With this union anyone can connect lead to threaded pipe without the use of solder. Simply flange the lead over the union collar, screw up the nut. Used on water and waste lines.  
¾" .... **98c** 1" .... **\$1.25** 1¼" .... **\$1.17** 1½" .... **\$1.43**

**Universal Coupling (B)**  
Connects casing to threaded pipe or fitting, Male or female.  
1¼" .... **95c** 1½" .... **95c**  
1½" x 1¼" .... **95c** 1½" x 1½" .... **95c**

**Slip Joint Nuts (C)**  
Casing to pipe.  
1¼" .... **25c** 1½" .... **25c**  
1½" x 1¼" .... **25c** 1½" x 1½" .... **25c**

**Bell Mouth Solder Bushing (D)**  
1¼" .... **25c** 1½" .... **30c** 2" .... **50c**

**Flush Solder Bushing (E)**  
1¼" .... **15c** 1½" .... **20c**  
1½" x 1¼" .... **25c** 1½" x 1½" .... **25c**

**Solder Nipples (F)**  
Male or female.  
¾" .... **25c** 1¼" .... **60c**  
1" .... **30c** 1½" .... **70c**  
¾" .... **40c**

**Solder Union (G)**  
¾" .... **40c** 1" .... **45c** ¾" .... **50c**

**Brass Closet Flange (H)**  
..... **50c**

**Brass Vent Tee (I)**  
1¼" .... **85c** 1½" .... **95c**

**Brass Ferrules (J)**  
2x1½" .... **45c** 2x2" .... **50c**  
4x4" .... **\$1.20**

**Gas Supplies**  
Just a few of the many items we carry in gas accessories. Visit our store for gas connections of all kinds.

**Gas Key**  
Cast brass to fit all cocks. Standard. .... **15c**  
3" .... **35c** 6" .... **45c**

**Gas Hose Cocks**  
Connect gas hose to threaded pipe or fitting. Male or female.  
¾" .... **39c** 1" .... **45c**

**Straight Gas Cock**  
Both ends threaded for pipe.  
¾" .... **45c** 1" .... **45c**

**Gas Hose Nipples**  
Connect gas hose to threaded pipe or fitting. Male or female.  
¾" .... **25c** 1" .... **25c**

**Gas Range Cock**  
Replaces broken valve on gas range or hot plate. ½" pipe thread.  
For gas range. .... **69c**  
For hot plate. .... **69c**

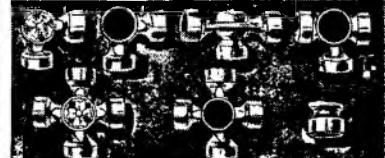

**Adjustable Malleable Railing Fittings**  
(H) Elbow. .... **\$1.53** 1¼" .... **\$1.99**  
(I) Side Outlet Elbow. .... **1.88** 2.22  
(J) Tee. .... **1.99** 2.61  
(K) Side Outlet Tee. .... **2.16** 2.81  
(L) Cross. .... **2.10** 2.83  
(M) Side Outlet Cross. .... **2.44** 3.22  
(N) Wall or Floor Flange. .... **.60** .69

**THE RIGHT TOOLS MAKE HOME PLUMBING EASY**

# SAVE ON ALL ELECTRICAL SUPPLIES

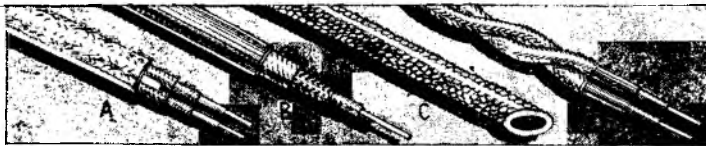

## COMPLETE WIRE NEEDS FOR INSIDE OR OUTSIDE

Regardless of the kind or type of wire you need, we have it, and at worthwhile savings.

### A. Non-Metallic Sheathed Cable

(Romex) Lighter in weight than armored Rubber covered wires in heavy fabric. Exceeds underwriter and code requirements.

| Size | No. Wires | 25 ft. | 50 ft. | 100 ft. | 250 ft. |
|------|-----------|--------|--------|---------|---------|
| 14   | 2         | 1.60   | 3.00   | 4.95    | 10.95   |
| 14   | 3         | 2.25   | 4.25   | 8.00    | 19.35   |
| 12   | 2         | 2.00   | 3.75   | 7.00    | 16.25   |

### B. Solid Rubber Covered Wire. Single braid. Approved by Underwriters. Easily stripped. Flame retarding annealed copper wire tinned for soldering.

| Size | 25 ft. | 50 ft. | 100 ft. | 250 ft. |
|------|--------|--------|---------|---------|
| 14   | .38    | .69    | 1.35    | 6.75    |
| 12   | .50    | .93    | 1.85    | 9.18    |
| 10   | .95    | 1.70   | 2.98    | 13.95   |
| 8    | 1.00   | 1.85   | 3.64    | 22.50   |

### D. Cotton Twisted Lamp Cord. New code type C. Green and yellow with tracer. Used for extensions, drop cords, lamps. 1/2-in. insulation, stranded wires.

| Size | No. Wires | Per Foot | 250 ft. Spool |
|------|-----------|----------|---------------|
| 18   | 2         | .03      | 6.25          |

### Solid Weatherproof Rubber Covered Wire

| Size | 25 ft. | 50 ft. | 100 ft. | 250 ft. |
|------|--------|--------|---------|---------|
| 14   | .50    | .93    | 1.84    | 7.50    |
| 12   | .63    | 1.17   | 2.32    | 10.25   |
| 10   | .98    | 1.75   | 3.25    | 14.95   |
| 8    | 1.40   | 2.60   | 4.90    | 23.95   |

### Plastic Lamp Cord Asst. Colors

| Size | No. Wires | Per Ft. | 100 ft. | 250 ft. |
|------|-----------|---------|---------|---------|
| 18   | 2         | .02 1/2 | 2.30    | 5.00    |

### Free Planning Service

Without obligation, we shall be pleased to figure the cost of lighting fixtures or wire materials. Mail or bring a sketch of your rooms and their sizes to our store.

### GANGABLE CABLE AND CONDUIT BOXES

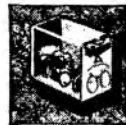

With two flanged steel clamps for armored cable, non-metallic sheathed or loom. 2 1/2 in. KO's in sides. Our low prices.

Heavy black enameled steel. 1/2-in. knockouts on sides and bottom for ganging. At our usual low, money-saving prices.

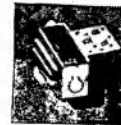

| Type               | Size      | Price |
|--------------------|-----------|-------|
| Shallow            | 3x2x2     | 22c   |
| Deep               | 3x3x2 1/2 | 25c   |
| Deep with brackets | 3x2x2 1/2 | 30c   |

| Type                  | Size      | Price |
|-----------------------|-----------|-------|
| Shallow               | 3x2x2     | 21c   |
| Shallow with brackets | 3x2x2     | 23c   |
| Deep                  | 3x2x2 1/2 | 28c   |

# HOUSEHOLD ELECTRIC NEEDS



- HEATER PLUG with switch..... 39c
- HEATER PLUG, without switch..... 29c
- CAP, Bakelite, Sturdy as they come..... 6c
- FLAT CAP, Handy grip..... 7c
- HANDLE CAP, Built for hard usage..... 10c
- RUBBER HANDLE CAP, Spring blade..... 10c
- PLUG BASE..... 7c
- 3-WAY CUBE TAP, 3-outlets in one..... 12c
- PULL CHAIN CURRENT TAP..... 29c
- 3-WAY SOCKET, 2 plug-ins, 1 socket..... 15c
- TWIN SOCKETS, Strong, convenient..... 15c
- PORCELAIN NAIL KNOBS..... 3c
- 2-WAY TABLE TAP, Easy to install..... 13c
- 3-WAY TABLE TAP, Installs firmly..... 19c
- TRIPLE TAP-IN. Meets many needs..... 19c
- PORCELAIN TUBES, Shock resisting... 2c
- INSULATED STAPLES, Box of 50..... 15c
- SOLDER. Acid core, good quality..... 12c
- TAPE. 4-oz. Rubber..... 29c
- 1-oz. Friction..... 10c
- 4-oz. Friction..... 24c



### ARMORED BUSHED CABLE

Easily installed, strips clean. Every foot thoroughly tested and guaranteed against breakdown. Flexible, heavy galvanized steel armor, insulation. Exceeds underwriters' laboratory, and code requirements.

| Size | No. Wires | 25 ft. | 50 ft. | 100 ft. | 250 ft. Coil |
|------|-----------|--------|--------|---------|--------------|
| 14   | 2         | 1.50   | 3.25   | 6.25    | 14.95        |
| 14   | 3         | 2.50   | 4.50   | 8.75    | 19.95        |
| 12   | 2         | 2.25   | 4.19   | 8.75    | 18.75        |



### DOOR BELL ACCESSORIES

- A. Double Coil Doorbell, operates on 2 dry cells or transformer..... \$1.19
- B. Double Coil Buzzer, enameled finish use 2 dry cells or transformer..... 69c
- C. Transformer, 6 to 8-volt. Easily attached, surface type..... \$1.19
- D. Bakelite Push Button, modern design, rich brown finish..... 29c

### SWITCH AND RECEPTACLE NEEDS

- A. TOGGLE SWITCH
- Ea. 23c 10 for \$1.98
- 3-way. Each..... 35c

### B. FLUSH PUSH SWITCH

Ea. 15c

### C. FLUSH RECEPTACLE

Brown, Ea. 12c 10 for \$1.15

Ivory Ea. 18c 10 for \$1.75

### D. KEY SOCKETS

1/2-in. Cap. Each..... 29c

### E. PULL CHAIN SOCKET

1/2-in. Cap. Each..... 35c

### F. PORCELAIN SOCKETS with PENDANT CAP

Pull, Ea. 39c Key, Ea. 39c

### G. BAKELITE SOCKETS

Pull, ea. 35c Key, Ea. 35c

### H. SIGN RECEPTACLE

Keyless. 9-in. pigtails, Ea. 15c

### I. 3-PIECE SIGN RECEPTACLE-PULL CHAIN

Each..... 29c

### J. TOGGLE SWITCH

Ea. 25c 3-way, Ea. 49c

### K. TOGGLE SURFACE SWITCH ON OUTLET BOX PLATE

3 1/4-in. or 4-in. Each..... 29c

### L. DUPLEX RECEPTACLE ON PLATE

3 1/4-in. or 4-in. Each..... 19c

### M. PENDANT SWITCH

Bakelite with plug-in. Blk., Ea. 23c Ivory, Ea. 32c

### N. FEEDTHRU BAKELITE SWITCH. Ea. 33c

### O. CANOPY SWITCH

Short ball chain, 4-ft. of cord. Each..... 59c

### P. CANOPY SWITCH

Rotary. 6 in. leads, Ea. 49c

### Q. CANOPY SWITCH

Levolier. 500-watt, Ea. 59c

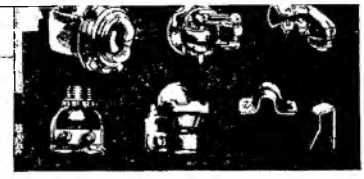

### BX-ROMEX FITTINGS

#### A. Armored Cable Connectors, (set screw type). Fits 1/2-in. knockout. Ea. 17c

#### B. Squeeze Type BX or ROMEX Connector, two screw squeeze type. Each..... 8c

#### C. Angle Armored Cable Connector, two screw squeeze type. Fits 1/2-in. knockout. Each..... 23c

#### D. Duplex Armored Cable Connector (set screw type). For 2 BX wire, fits 1/2-in. knockout. Each..... 19c

#### E. BX or ROMEX Servet, mounts on armored or non-metallic sheathed cable. Each..... 19c

#### F. Galvanized Straps, 1/2-in. to 1 1/2-in. 2 for..... 5c

#### G. Cable Staples, for fastening BX or ROMEX 12 for..... 6c

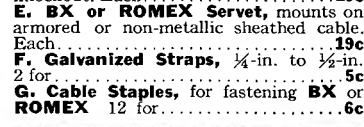

### SERVICE ENTRANCE CABLE AND WATERPROOF FITTINGS

#### A. SERVICE ENTRANCE CABLE Per ft.

a. 1 No. 8 wire and 1 No. 8 bare wire..... 15c

b. 2 No. 8 wires and 1 No. 8 bare wire..... 21c

c. 2 No. 6 wires and 1 No. 6 bare wire..... 28c

#### B. SERVICE ENTRANCE HEAD

For use with a or b above. Each..... 79c

For use with c above. Each..... 69c

#### C. SERVICE CABLE STRAPS

For use with a, entrance cable. Each..... 6c

For use with b or c entrance cable. Ea..... 7c

#### D. ENTRANCE CABLE CONNECTORS

For use with a or b entrance cable..... 27c

For use with c, entrance cable..... 45c



### UTILITY OUTLETS

#### B. OCTAGON OUTLET BOXES

Five 1/2-in. knockouts in bottom, one in each side. 3 1/4-in. Ea. 19c 4-in. Ea. 21c

3 1/4 in. with 4-in. with clamps..... 29c clamps..... 39c



### RANGE OR GENERAL USE SWITCHES

#### A. General Purpose Switch. 30-ampere, 2-pole switch that bears the Underwriters' label for your protection. Wiring diagram supplied with each switch..... \$2.59

#### B. Sturdy Range Switch. Provides 60-ampere mains, one 60-ampere range and four complete 30-ampere circuits..... \$8.45

#### C. Underwriter Approved FUSES. Screw type, 10, 15, 20, 25, or 30 amp. Ea. 6c

We carry a complete line of entrance and Safety Switches for every type of installation.

### SHOCK-PROOF PORCELAIN RECEPTACLES

#### A. Pull chain outlet box. 3-in. chain, 4-ft. cord. 3 1/4-in. 39c 4-in. 49c

#### B. Keyless outlet box. Screw terminals, shade holder groove. 3 1/4-in. 19c 4-in. 25c

#### C. Receptacle on box cover open screw terminals. 3 1/4-in. 18c 4-in. 19c

We carry a complete line of entrance and Safety Switches for every type of installation.

### SHOCK-PROOF PORCELAIN RECEPTACLES

#### A. Pull chain outlet box. 3-in. chain, 4-ft. cord. 3 1/4-in. 39c 4-in. 49c

#### B. Keyless outlet box. Screw terminals, shade holder groove. 3 1/4-in. 19c 4-in. 25c

#### C. Receptacle on box cover open screw terminals. 3 1/4-in. 18c 4-in. 19c

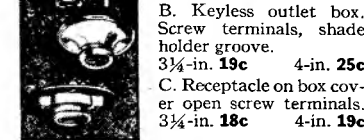

### TAKE ADVANTAGE OF THRIFTS —

# EASY TERMS



### NEW FIXTURES TO MAKE YOUR ROOMS SPARKLE!

- FOR LIVING ROOMS
- FOR DINING ROOMS
- FOR BEDROOMS
- FOR KITCHENS & BATHROOMS

Here are only a few of our immense stock of lighting fixtures... just come in and see the hundreds of exclusive new styles that are being featured for spring... all very moderately priced! All types are included too... so you can select just the fixture you need to make each room a thing of beauty!

HUNDREDS OF OTHER ITEMS—ALL PRICED RIGHT!

# HOME OWNERS! GET 100% PROTECTION AND LASTING BEAUTY WITH "DURO-BOND" PAINT!

... and whether you plan to repaint the outside of your house ... to redecorate the interior ... or just "touch up" a few articles here or there, there is a DURO-BOND Paint or Enamel to suit your every need! The colors are modern and in line with today's decorative trends—Rich! Colorful! Lasting! ... and the quality of DURO-BOND PAINTS have been proven by thousands of home owners all over the United States! Will not crack—scale—or peel!

## DURO-BOND OUTSIDE PAINT

**\$4.79**  
GALLON

One of the best house paints in the country ... made of the finest oils and pigments ... and covers so solidly that a gallon GOES FARTHER!

## DURO-BOND FLOOR ENAMEL

**\$1.10**    **\$3.69**  
QUART    GALLON

A smooth, washable finish for floor surfaces of wood, concrete, metal and composition inside or out! ... Brushes easily—dries quickly ... 12 colors.

## DURO-BOND QUICK ENAMEL

**\$1.39**    **\$4.69**  
QUART    GALLON

A perfect household enamel ... easy to apply ... quick to dry ... gives a smooth porcelain-gloss finish that withstands repeated washing ... 23 popular colors to select from!

## "BI-KOTE" OIL BASE WALL PAINT

**\$1.39**    **\$4.69**  
QUART    GALLON

A very fine paint that covers well over wall paper, masonite, beaver board, etc. ... one coat is plenty! ... dries to a sheen finish that washes easily ... and resists dirt and dust ... Many colors.

## BLACK SCREEN ENAMEL

**85c**  
QUART

## ABSORENE WALL PAPER CLEANER

18 Oz. 12c    10 Lbs. 98c

## "SOLAREX" TRIM & TRELIS COLORS

Comes in 6 bright colors for trim and trellis work ... guaranteed to withstand sun, heat, rain and snow.

**\$1.35**    **\$4.95**  
QUART    GALLON

## WHITE CREOSOTE OIL PAINT

**\$2.98**  
GALLON

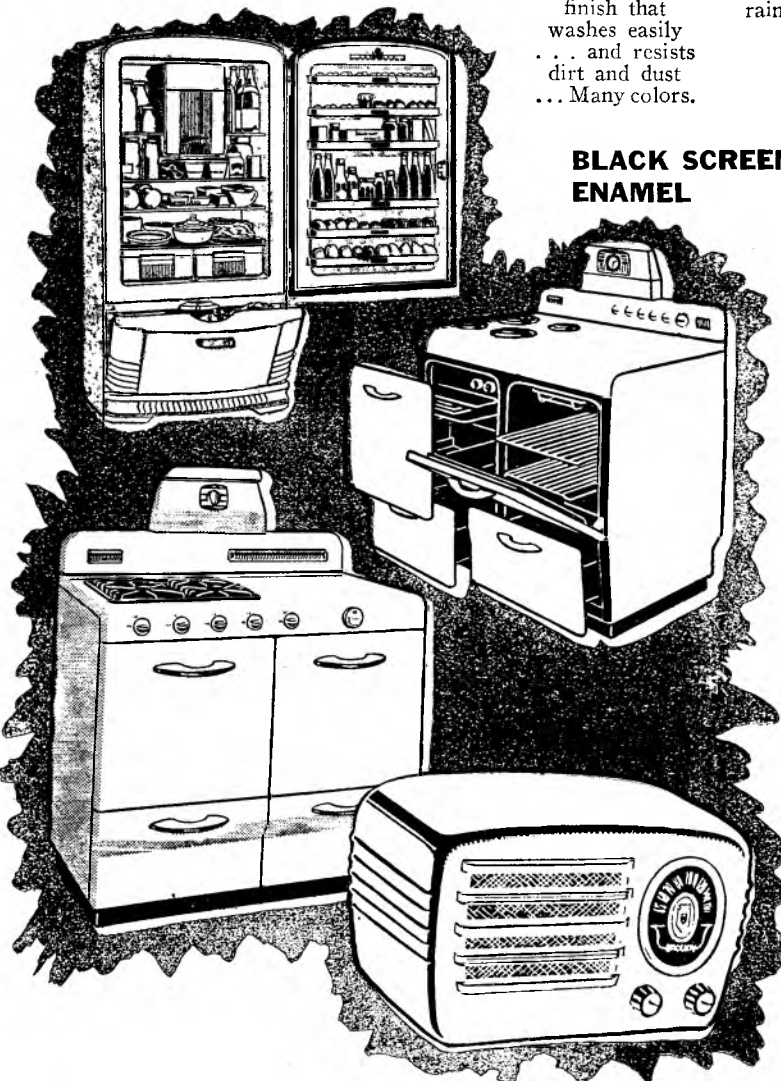

## ALL KINDS OF FINE QUALITY CROSLEY ELECTRICAL APPLIANCES

"Crosley"—a name that has stood for the best for many years—a name that guarantees you complete satisfaction on any item they manufacture! And, remember "Crosley" products reflect the years of Crosley's intensive research in the number of exclusive features that make living easier and safer. ... Here are a few—

### "CROSLEY" SHELV-A-DOR ELECTRIC REFRIGERATORS

7 cubic feet . . . . **\$289.00**  
9 cubic feet . . . . **329.00**

"CROSLEY" Electric Four Burner Range at . **\$249.95**

"CROSLEY" Gleaming White Gas Range at . **179.95**

"CROSLEY" Table Model 5 Tube Radio at . **17.95**

- ★ BRUSHES EASIER
- ★ GOES FARTHER
- ★ PROTECTS BETTER
- ★ LASTS LONGER



# LAWN and GARDEN SUPPLIES

## YES! THRIFT HAS PLENTY OF LAWN MOWERS!

HERE ARE 3 OF THE POPULAR MODELS!



### "COUNTRY TERRACE" LAWN GRASS SEED

New stock of that fast growing lawn mixture that will make your lawn a picture of beauty this summer.

- 1 pound bag . . . . . 49c
  - 3 pound bag . . . . . \$1.45
  - 5 pound bag . . . . . \$2.35
- (New Stock . . . specially grown)

### "COUNTRY TERRACE" KENTUCKY BLUE GRASS

- 1 pound bag . . . . . 59c
  - 3 pound bag . . . . . \$1.75
  - 5 pound bag . . . . . \$2.85
- (New Stock . . . specially grown)

### PURE RYE GRASS SEED

- 1 pound bag . . . . . 59c
  - 3 pound bag . . . . . 35c
  - 5 pound bag . . . . . 59c
- (None better . . . no matter how much more you pay)

### LAWN LIME FERTILIZER

- 10 pounds for 15c
- 50 pound bag for 49c



- 10 Pounds 85c
- 25 Pounds \$1.49
- 100 Pounds \$3.98

### MILORGANITE

. . . a chemical fertilizer that will make your lawn and flowers GROW and G-R-O-W!

- 25 pound bag . . . . . \$1.19
- 50 pound bag . . . . . \$1.98
- 100 pound bag . . . . . \$3.19

### COW FERTILIZER

- 25 pound bag . . . . . 65c
- 50 pound bag . . . . . \$1.19
- 100 pound bag . . . . . \$2.19

Because of the limited space, we cannot show all of the garden aids that we carry. Visit our store . . . see our complete, plainly priced displays.

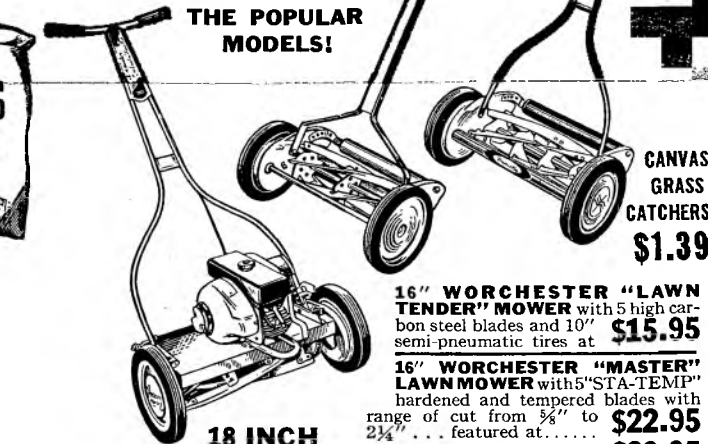

### 18 INCH WORCHESTER POWER LAWN MOWERS \$107.95

A rugged "easy to operate" two cycle engine lawn mower with 10" semi-pneumatic tires . . . ball bearing crankshaft . . . will make grass cutting a pleasure instead of a chore.

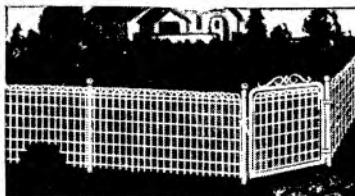

**ORNAMENTAL FENCE**, of heavy copper bearing galvanized steel wire. Neat in appearance, that assures privacy. Prices listed are 100 ft. rolls, cut prices are slightly higher.

|                              |               |               |  |
|------------------------------|---------------|---------------|--|
| Per foot as low as . . . . . | 12½c          |               |  |
| Size                         | Single Bottom | Double Bottom |  |
| 36                           | 12½c          | 16½c          |  |
| 42                           | 13½c          | 17½c          |  |
| 48                           | 15½c          | 19½c          |  |

**ORNAMENTAL GATES**, to match your new fence. Sturdy gate frame of heavy steel tube. Wire doubled and twisted for added strength.

|           |        |           |        |
|-----------|--------|-----------|--------|
| Size      | Price  | Size      | Price  |
| 30x36 in. | \$4.39 | 36x36 in. | \$4.49 |
| 36x42 in. | 4.69   | 42x48 in. | 5.19   |

**STEEL FENCE POSTS**, used to prevent sagging, gives added strength to all fences. 5½ ft. . . . . 65c 6 ft. . . . . 70c

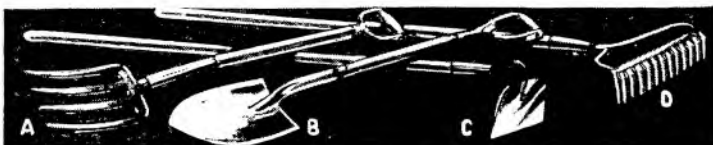

(A) **SPADING FORK**, easy grip, 4 extra heavy tines reinforced directly to handle. . . . . \$1.98  
 (B) **GARDEN SPADE**, round point steel blade. . . sturdy handle. Our price, only \$1.69

(C) **GARDEN HOE**, heavy, sharp, steel blade with smooth ash handle, only . . . 98c  
 (D) **14 TEETH RAKE**, level steel head with straight teeth. Sturdy, smooth handle, only . . . . . 89c



**HERE'S A WOOD GARDEN BARROW** that is very popular with home gardeners as it is big and roomy . . . easily handled too . . . a big value at . . . . . \$7.95

If you prefer a metal tray **WHEEL BARROW** with wood handles, here's a dandy with reinforced edges and built to stand lots of abuse . . . only . . . \$6.95 WITH IRON HANDLES AT . . . \$8.95



**GARDEN PLOW** \$3.98  
 A Handy high wheel garden plow with 4" steel shovel — 5 prong cultivator — and small cultivator blade. . . . . \$3.98

**ALL STEEL LAWN ROLLERS** that can be adjusted to any desired weight . . . you'll need one this spring . . . only \$13.95

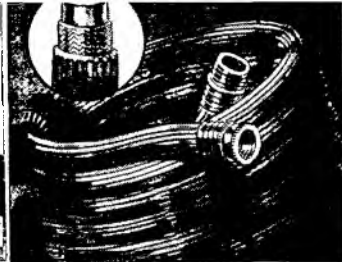

**¾-IN. ALL RUBBER HOSE**  
 One year guarantee. Good quality black rubber hose for garden, basement, garage, and many other uses. Full 25 ft. lengths with necessary couplings, our low price is only \$1.79

50 FEET . . . . . \$2.98

**SINGLE BRAID HOSE**  
 Another excellent quality hose with a 5 year guarantee. 25 ft. lengths, complete with all necessary couplings. . . . . \$2.98

50 FEET . . . . . \$4.98

**EXTRA HEAVY GREEN HOSE**  
 Five year guarantee, on this deluxe quality, double braid hose. 25 ft. lengths complete with all couplings. . . . . \$3.98

50 FEET . . . . . \$6.98



1. **GRASS HOOK WITH** a tempered steel blade . . . . . hardwood handle at . . . . . 39c
2. **HEDGE SHEARS** with durable easily sharpened blades and reinforced handles at \$1.89
3. **WEED CUTTER** with an easy swinging steel blade . . . \$1.19 at . . . . .
4. **GRASS WHIP** with sharp steel shaft . . . used like a golf club, at . . . . . \$1.19
5. **"RAIN CHIEF" LAWN SPRINKLER** . . . a revolving sprinkler that does the work! . . . only . . . . . 98c
6. **METAL LEAF RAKE** . . . 79c only . . . . .
7. **PRUNING SHEARS** . . . of heavy metal construction . . . a bargain at . . . . . 39c
8. **BRASS HOSE NOZZLE** . . . ruggedly built . . . adjustable spray . . . only . . . . . 29c

# HEATING HEADQUARTERS FOR THRIFTY HOME-OWNERS

Every Part For Every Furnace at Lowest Prices

Whether you are installing a new furnace or merely making repairs, you will find what you need in our complete stock of pipe and fittings, which conform to the high quality of the Standard Heating Code and are priced to save you money. Shown here are only the most frequently used items. Visit our store for correct selection.

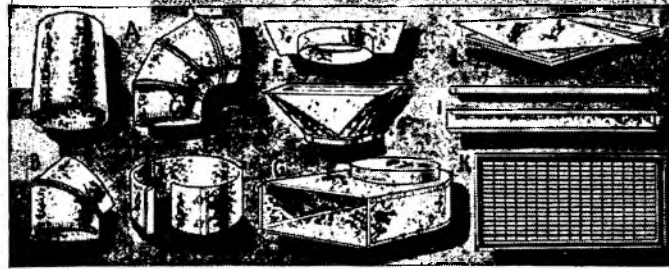

## COLD AIR PIPE AND FITTINGS

|  | 16"    | 18"    | 20"    | 22"    | 24"    |
|--|--------|--------|--------|--------|--------|
| (A) Pipe per 2-foot length.....  | \$1.83 | \$2.18 | \$2.60 | \$3.10 | \$3.66 |
| (B) 45° angle, adjustable, each.....   | 1.71   | 2.12   | 2.65   | 2.94   | 3.41   |
| (C) Elbow, adjustable, each.....   | 3.42   | 4.24   | 5.30   | 5.88   | 6.82   |
| (D) Draw Band, each.....   | 1.18   | 1.42   | 1.60   | 1.85   | 2.31   |
| (E) Ceiling Plate, each.....   | 2.05   | 2.23   | 2.56   | 2.90   | 3.26   |
| (F) Transition Head, each.....   | 4.09   | 4.45   | 5.12   | 5.80   | 6.51   |
| (G) Shoe, each.....  | 6.05   | 7.01   | 7.97   | 9.11   | 10.24  |
| (H) Stiffener, 4 ft. long, each.....   |        |        |        |        | .42    |
| (I) Side Rail, 10 in. by 8 ft. long, each.....   |        |        |        |        | 2.51   |
| (J) Steel Sheet, 36"x96", each.....  |        |        |        |        | 3.50   |
| (K) Steel Cold 8"x30" 10"x30" 12"x30" 14"x30" 16"x30" 18"x30" 20"x30" Air Face... \$4.11 \$4.21 \$4.56 \$5.27 \$6.27 \$7.00 \$7.65 |        |        |        |        |        |

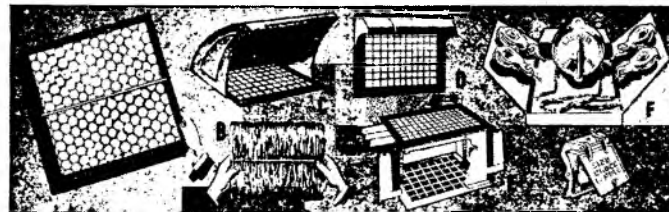

## WARM AIR NEEDS AT MONEY-SAVING PRICES

|   |                |
|---|----------------|
| (A) Filter for air conditioning furnace. Size 16"x20", 20"x20", or 16"x25"....  | \$1.50         |
| (B) Dust Catcher. Catches dust and dirt. Saves decorating and laundry bills. To fit registers 8"x10" \$1.19—9"x12" \$2.23—10"x12" \$3.31—12"x14"..... | .33            |
| (C) Floor Register Shield, adjustable.....  | 1.29           |
| (D) Wall Register Shield, adjustable.....   | .79            |
| (E) Floor and Ceiling Ventilator, to convey heat from lower to upper room or through the wall. Easily installed. Size 8"x10" \$2.77—Size 9"x12"....   | 3.68           |
| (F) Damper Regulator for warm air furnace, with pulley and chain.....   | 1.98           |
| (G) Saddle Check Damper for smoke pipes. For 8" pipe, \$1.85—For 9" pipe.....   | 1.98           |
| (The following are not illustrated.)  |                |
| Furnace Chain, per foot, \$0.05.....  | .50 ft. 1.49   |
| Sheet Metal Screws. Per doz. \$1.15.....  | per gross 1.25 |
| Stove Pipe Wire, standard coil.....   | .10            |

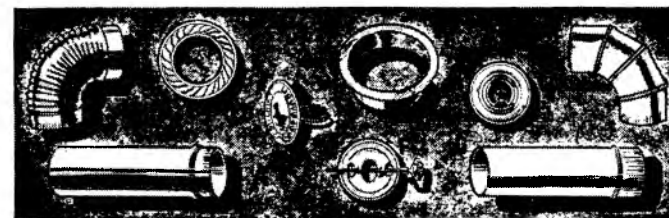

## SAVE MONEY ON STOVE PIPE AND FITTINGS

|  | 3"     | 4"     | 5"     | 6"     | 7"     |
|--|--------|--------|--------|--------|--------|
| (A) Stove Pipe, per 2 ft. length.....                        | \$0.31 | \$0.32 | \$0.34 | \$0.36 | \$0.41 |
| (B) Stove Pipe Elbow.....                                    | .29    | .30    | .31    | .32    | .38    |
| (C) Stove Pipe Collar.....                                   | .13    | .13    | .13    | .13    | .13    |
| (D) Flue Stopper.....  | .13    | .13    | .13    | .13    | .13    |
| (E) Cast Iron Flue Ring.....                                 | .53    | .62    | .70    | .77    | .77    |
| (F) Cast Iron Damper.....                                    | .23    | .24    | .25    | .29    | .44    |
| (G) Nickel Plated Stove Pipe, size 4", per 2 ft. length..... |        |        |        |        | .69    |
| (H) Nickel Plated Stove Pipe Elbow, size 4", each.....       |        |        |        |        | .60    |
| (I) Nickel Plated Stove Pipe Collar, size 4", each.....      |        |        |        |        | .34    |

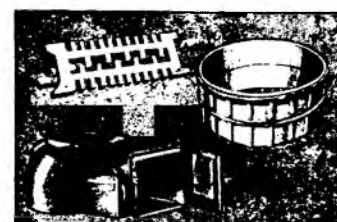

## FURNACE REPAIRS

We Can Furnish Any Part for Any Make of Furnace

Being specialists in all types of heating, we can furnish parts for any furnace or boiler, regardless of make or model. Just let us have the name and model number (you'll find it on the front of your furnace or boiler) and we'll supply the exact part required. Quick delivery assured on all firepots, feed sections, grates, shaker handles, boiler sections, etc. If you wish, we shall furnish an experienced furnace installer to do your repair job.

**Smoke Pipe and Fittings**  
Heavy gauge construction with patented lock seam.

| Pipe     |        |
|----------|--------|
| 6".....  | \$ .69 |
| 7".....  | .82    |
| 8".....  | 1.11   |
| 9".....  | \$1.23 |
| 10"..... | 1.39   |
| 12"..... | 1.61   |

| Elbow, 90°  |        |
|-------------|--------|
| Adjustable. |        |
| 6".....     | \$ .74 |
| 7".....     | .84    |
| 8".....     | 1.03   |
| 9".....     | \$1.15 |
| 10".....    | 1.28   |
| 12".....    | 1.62   |

| Angle, 45°  |        |
|-------------|--------|
| Adjustable. |        |
| 7".....     | \$ .66 |
| 8".....     | .77    |
| 9".....     | .81    |
| 10".....    | \$ .92 |
| 12".....    | 1.10   |

| Tee  |         |         |
|--|---------|---------|
| Used frequently on smoke pipe to provide cleanout. |         |         |
| 7".....  | 8"..... | 9"..... |
| \$2.05   | \$2.35  | \$2.93  |

| Draw Band                               |          |          |
|---|----------|----------|
| Serves as union on smoke pipe assembly. |          |          |
| 7".....                                 | 10"..... | 8".....  |
| \$ .62                                  | \$ .81   | \$ .88   |
| 8".....                                 | .67      | 12"..... |
| 9".....                                 | .73      | .88      |

| Cleanout Cap                   |         |         |
|--------------------------------|---------|---------|
| Fits snugly in opening of tee. |         |         |
| 7".....                        | 8"..... | 9"..... |
| \$ .73                         | \$ .81  | \$ .88  |

| Cast Iron Damper         |         |          |
|--------------------------|---------|----------|
| Easily inserted in pipe. |         |          |
| 6".....                  | 9"..... | 10"..... |
| \$ .29                   | \$1.05  | \$1.31   |
| 7".....                  | .44     | 12"..... |
| 8".....                  | .70     | 1.57     |

| Cast Iron Flue Ring |         |          |
|---------------------|---------|----------|
| 6".....             | 9"..... | 10"..... |
| \$ .70              | \$1.43  | \$2.09   |
| 7".....             | .77     | 12"..... |
| 8".....             | 1.06    | 3.30     |

**Basement Pipe and Fittings**  
Material listed below is used for floor registers on the first floor and to connect second floor wall pipe to furnace.

| Floor Register |               |
|----------------|---------------|
| 8x10, \$1.93   | 10x12, \$2.71 |
| 9x12, 2.42     | 12x14, 4.78   |

| Register Floor Box |               |
|--------------------|---------------|
| 8x10, \$1.42       | 10x12, \$1.71 |
| 9x12, 1.57         | 12x14, 2.06   |

| Blank Register Floor Box |               |
|--------------------------|---------------|
| 8x10, \$1.42             | 10x12, \$1.71 |
| 9x12, 1.57               | 12x14, 2.06   |

| Adjustable Elbow, 90° |          |          |
|-----------------------|----------|----------|
| 6".....               | 7".....  | 8".....  |
| \$ .65                | \$ .72   | \$ .80   |
| 9".....               | 10"..... | 12"..... |
| \$ .97                | \$1.20   |          |

| Adjustable Angle, 45° |          |          |
|-----------------------|----------|----------|
| 6".....               | 7".....  | 8".....  |
| \$ .53                | \$ .57   | \$ .61   |
| 9".....               | 10"..... | 12"..... |
| \$ .70                | \$ .84   |          |

| Basement Pipe                                  |          |         |         |
|--|----------|---------|---------|
| Easily assembled and locked, per 2 ft. length. |          |         |         |
| 6".....  | 7".....  | 8"..... | 9"..... |
| \$ .58   | \$ .68   | \$ .76  | \$ .84  |
| 10".....                                       | 12"..... |         |         |
| \$ .92   | \$1.11   |         |         |

| Sheet Metal Dampers          |         |          |          |
|------------------------------|---------|----------|----------|
| Insert in pipe near furnace. |         |          |          |
| 8".....                      | 9"..... | 10"..... | 12"..... |
| \$ .48                       | \$ .56  | \$ .64   | \$ .80   |

| Casing Collars            |         |          |          |
|---------------------------|---------|----------|----------|
| Insert in furnace casing. |         |          |          |
| 8".....                   | 9"..... | 10"..... | 12"..... |
| \$ .46                    | \$ .53  | \$ .57   | \$ .68   |

### Fittings for Second Floor Registers

The inside measurements of No. 7 pipe are 3 1/4"x10", of No. 8 pipe, 3 1/4"x12".

### Wall Registers

Black.  
8x10, \$1.84 9x12, \$2.36

### Wall Box for One Register

No. 7 for 8x10... \$1.35  
No. 8 for 9x12... 1.53

### Wall Box for Two Registers

No. 7 for 8x10... \$1.57  
No. 8 for 9x12... 1.71

### Galv. Wall Pipe

| No. 7             | No. 8  |
|-------------------|--------|
| 5" long... \$ .53 | \$ .57 |
| 15" long... .89   | .96    |
| 24" long... 1.32  | 1.42   |
| 30" long... 1.46  | 1.60   |

### Wall Pipe Ell

Galvanized.  
No. 7, \$1.35 No. 8, \$1.49

### Wall Pipe Angle

Galvanized.  
No. 7, \$1.07 No. 8, \$1.10

### Boot, 90°

Galvanized.  
No. 7, \$1.64 No. 8, \$1.78

### Boot, 45°

Galvanized.  
No. 7, \$1.64 No. 8, \$1.78

### Boot—Straight

Galvanized.  
No. 7, \$1.28 No. 8, \$1.42

### Increase

Increase boot collar for larger basement pipe where necessary.  
8x9, 57c 9x10, 64c

We also stock single and double pipe and fittings in both old and new sizes.

## THERMOSTAT COMFORT CONTROL



Makes Your Heating System Automatic **\$22.90**

Gives automatic, unvarying heat. Simply set the thermostat for the temperature you find comfortable. In mild or bitter weather, your home is maintained at a uniform temperature, because the thermostat operates with an accuracy of 2 degrees. Instantly adjustable for day or night. Safeguards against overheating... economizes on fuel. Eliminates worry... saves basement trips. Easily installed on your hot water, steam, or warm air system. Complete... \$22.90



### AUTOMATIC HUMIDIFIER

Supplies proper moisture to heated air. Safeguards against sickness... prevents furniture and woodwork from drying out. Entirely automatic. Easily connected to your water line and installed in your present furnace. Complete... \$11.75  
Radiator humidifier... \$9.95

THOUSANDS OF OTHER ITEMS ON DISPLAY. ALL PRICES PLAINLY MARKED

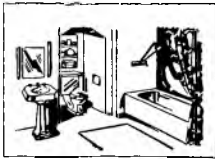
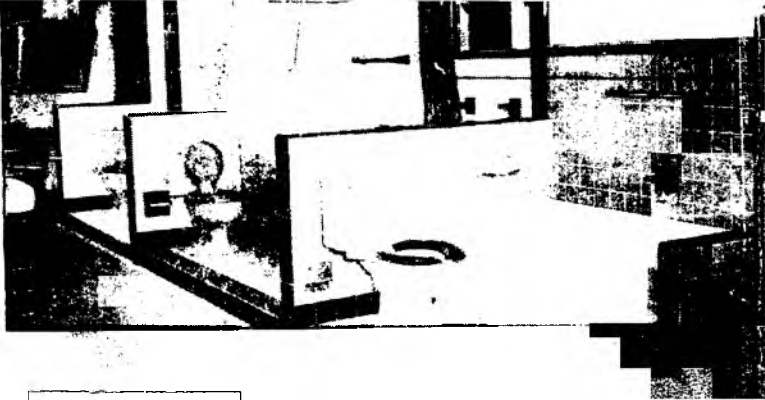

PLUMBING

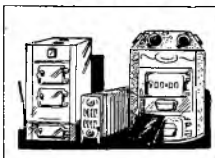

HEATING



KITCHENS

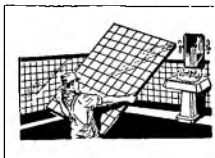

TILEBOARD

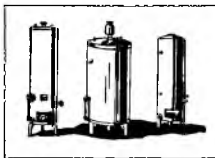

WATER HEATERS

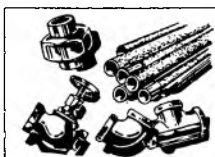

PIPE & FITTINGS



REPAIR PARTS

### THIS CATALOG

This is your copy of the new "Home Owner's Thrift Guide." It has been prepared at considerable cost to give you a reliable catalog for all your plumbing and heating needs... to serve as a Buyer's Digest of all that's smart and new in home modernization. Check through the thousands of illustrated items. All are plainly described and priced. Then, keep this guide handy. It will save you time and money whenever you need anything for the home.

### OUR STORE

Unlike a number of mail order catalogs... these catalog prices are our store prices. You pay no penalty just because—like all alert buyers you want to see merchandise before you buy. Visit our store. It's your privilege to see, touch, operate, examine any item. Feel free to inspect our complete displays of bathroom, kitchen, laundry, heating, and other supplies at your own leisure. They're all arranged just as they would appear in your own home—all are plainly priced. The pictures show in just a small way the pleasant shopping surroundings here. Parking facilities, courteous salesmen, and an eager desire to be of service await you, too.

### THE JOB WE'RE TRYING TO DO

Our purpose in sending you this catalog... our purpose in doing business at all... is to help you obtain the necessary things to make your home a happier place to live in—at a moderate cost to you and at a reasonable profit to ourselves. We do not pretend to be giving away anything for nothing. We do not claim to be able to work miracles in your home. But, we do give every effort to providing you with quality materials at the lowest possible cost. We try to maintain complete and varied stocks, ready for immediate delivery. Also we try to give you our frank, sincere advice as to just what will give you the best service. We want to give you material that will satisfy in every way. If we make a mistake—and who doesn't—we are glad to rectify it. After all, we're just a group of everyday humans, fired with a desire to do an honest job, backed with an unusually thorough knowledge of plumbing and heating. Won't you visit our store and let us show you how we can help you?

CATALOG S-48  
OVER HALF MILLION COPIES

SEC. 562, P. L. & R.

U.S. POSTAGE  
**PAID**  
PERMIT No.  
1923



Here's Your HOME OWNER'S

# THRIFT GUIDE

in time for your  
*Spring*—  
**PLANNING**

A Handy Digest for  
Buyers Digest for  
everything  
**FOR THE HOME!**

